



8020A

instruction manual

This manual documents the Model 8020A and its assemblies at the revision level shown in Appendix A. If your instrument contains assemblies with different revision letters, it will be necessary for you to either update or backdate this manual. Refer to the supplemental change/errata sheet for newer assemblies, or to the Appendix A for older assemblies.

John Fluke Mfg. Co., Inc. • P.O. Box 43210 • Mountlake Terrace, Washington 98043

Rev. 1 8/77

Rev. 2 5/78

Dear Customer:

Congratulations! We at Fluke are proud to present you with the Model 8020A Multimeter. This instrument represents the very latest in integrated circuit and display technology. As a result, the end product is a rugged and reliable instrument whose performance and design exhibit the qualities of a finely engineered lab instrument. It also provides some unique measurement capabilities in addition to those normally found in an ordinary multimeter.

To fully appreciate and protect your investment, we suggest that you take a few moments to read the manual. As always, Fluke stands behind your 8020A with a full one-year warranty and a worldwide service organization. If the need arises, please don't hesitate to call on us

Thank you for your trust and confidence.

JOHN FLUKE MFG. CO., INC.



static awareness



A Message From
John Fluke Mfg. Co., Inc.

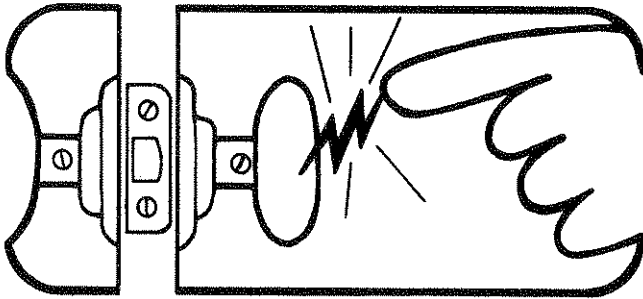

Some semiconductors and custom IC's can be damaged by electrostatic discharge during handling. This notice explains how you can minimize the chances of destroying such devices by:

1. Knowing that there is a problem.
2. Learning the guidelines for handling them.
3. Using the procedures, and packaging and bench techniques that are recommended.

The Static Sensitive (S.S.) devices are identified in the Fluke technical manual parts list with the symbol



The following practices should be followed to minimize damage to S.S. devices.

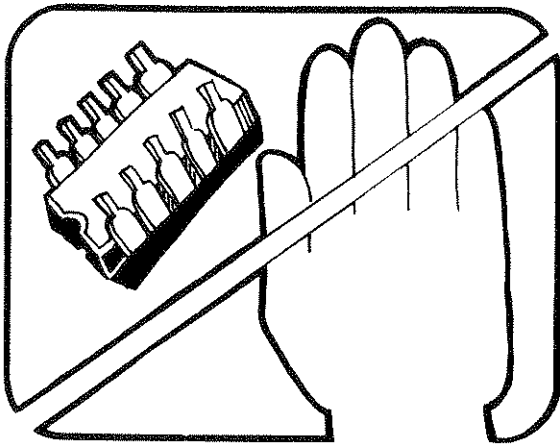

1. MINIMIZE HANDLING

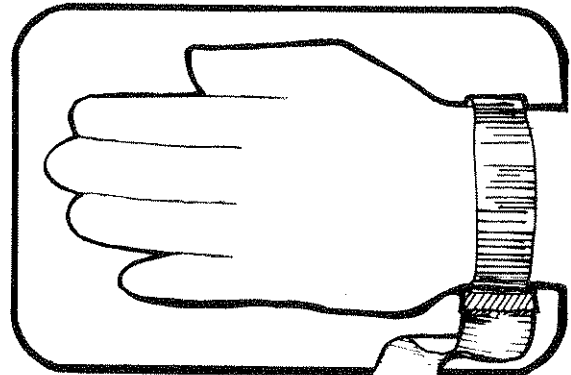

3. DISCHARGE PERSONAL STATIC BEFORE HANDLING DEVICES

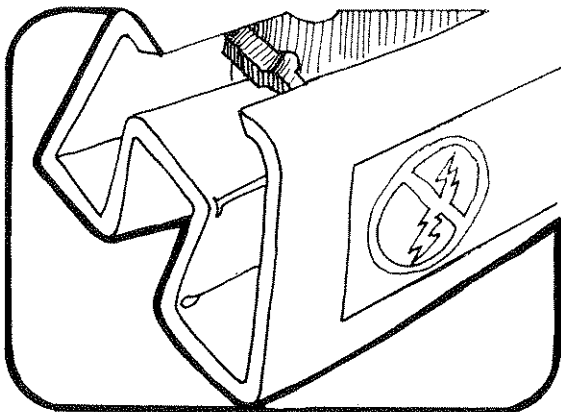

2. KEEP PARTS IN ORIGINAL CONTAINERS UNTIL READY FOR USE.

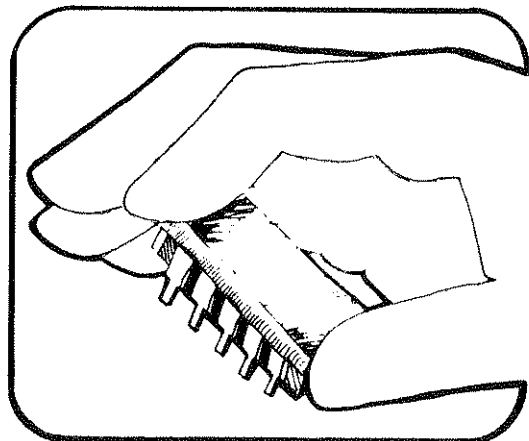

4. HANDLE S.S. DEVICES BY THE BODY

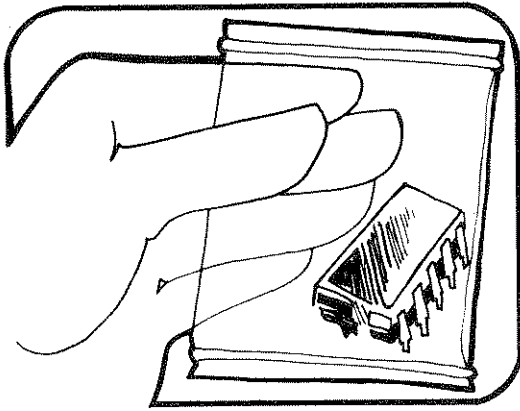

5. USE ANTI-STATIC CONTAINERS FOR HANDLING AND TRANSPORT

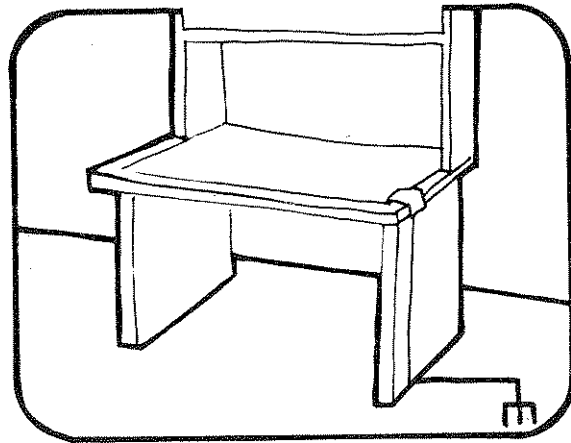

8. HANDLE S.S. DEVICES ONLY AT A STATIC-FREE WORK STATION

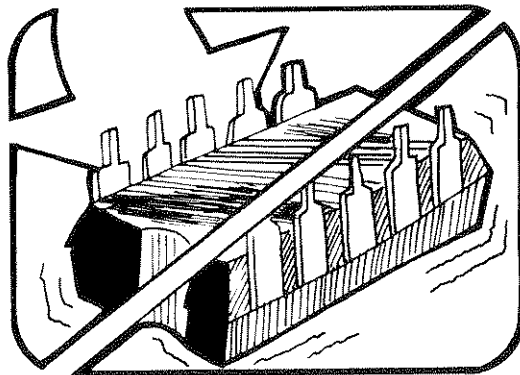

6. DO NOT SLIDE S.S. DEVICES OVER ANY SURFACE

9. ONLY ANTI-STATIC TYPE SOLDER-SUCKERS SHOULD BE USED.

10. ONLY GROUNDED TIP SOLDERING IRONS SHOULD BE USED.

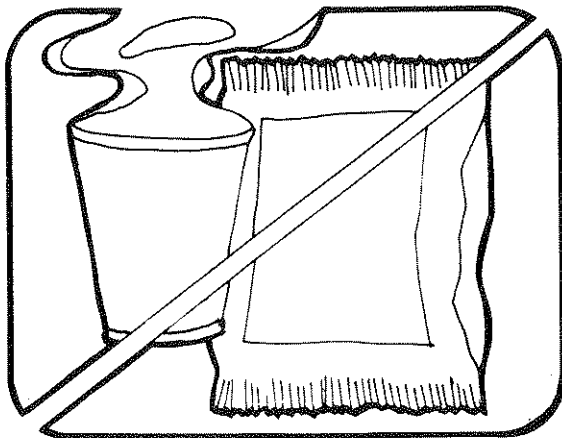

7. AVOID PLASTIC, VINYL AND STYROFOAM IN WORK AREA

Anti-static bags, for storing S.S. devices or pcbs with these devices on them, can be ordered from the John Fluke Mfg. Co., Inc.. See section 5 in any Fluke technical manual for ordering instructions. Use the following part numbers when ordering these special bags.

John Fluke Part No.	Bag Size
453522	6" x 8"
453530	8" x 12"
453548	16" x 24"
454025	12" x 15"

Table of Contents

SECTION	TITLE	PAGE
1	INTRODUCTION AND SPECIFICATIONS	1-1
1-1.	INTRODUCTION	1-1
1-3.	PREPARING FOR OPERATION	1-1
1-1.	Unpacking	1-1
1-6.	Battery Installation	1-2
1-8.	GETTING ACQUAINTED	1-2
1-10.	Physical Features	1-2
1-12.	Initial Check-Out Procedure	1-2
1-14.	SPECIFICATIONS	1-4
2	OPERATING INSTRUCTIONS	2-1
2-10.	INTRODUCTION	2-1
2-3.	OPERATING NOTES	2-1
2-5.	Input Power	2-1
2-12.	Display Readings	2-2
2-15.	Input Connections to COMMON	2-2
2-17.	Input Overload Protection	2-2
2-19.	Fuse Replacement	2-3
2-22.	AC Measurement	2-3
2-24.	Resistance	2-3
2-27.	Voltage AC/DC	2-4
2-30.	Current AC/DC	2-5
2-33.	Conductance	2-5
2-37.	OPERATION	2-6
2-39.	APPLICATIONS	2-6
2-41.	Transistor Tester	2-7
2-46.	Leakage Tester	2-8
3	THEORY OF OPERATIONS	3-1
3-1.	INTRODUCTION	3-1
3-3.	OVERALL FUNCTIONAL DESCRIPTION	3-1
3-8.	BLOCK DIAGRAM ANALYSIS	3-2
3-9.	A/D Converter	3-2
3-18.	Input Signal Conditioners	3-2
4	MAINTENANCE	4-1
4-1.	INTRODUCTION	4-1
4-3.	SERVICE INFORMATION	4-1
4-7.	GENERAL INFORMATION	4-2

SECTION	TITLE	PAGE
4-8.	Access Information	4-2
4-17.	Cleaning	4-3
4-19.	Battery/ Fuse Replacement	4-3
4-21.	PERFORMANCE TEST	4-3
4-23.	Initial Procedure	4-3
4-25.	Display Test	4-3
4-27.	Resistance/ Conductance Test	4-4
4-29.	DC Voltage Test.....	4-4
4-31.	AC Voltage Test.....	4-4
4-33.	DC Current Test.....	4-5
4-35.	CALIBRATION	4-5
4-38.	TROUBLESHOOTING	4-5
5	LIST OF REPLACEABLE PARTS.....	5-1
5-1.	INTRODUCTION.....	5-1
5-4.	HOW TO OBTAIN PARTS	5-1
6	OPTIONS AND ACCESSORIES	6-1
6-1.	INTRODUCTION.....	6-1
6-3.	DELUXE CARRYING CASE (C90).....	6-1
6-5.	BATTERY ELIMINATOR (A81)	6-1
6-7.	TEMPERATURE PROBE (80T-150).....	6-2
6-8.	Introduction	6-2
6-10.	Specifications.....	6-2
6-11.	CURRENT TRANSFORMER (80I-600)	6-2
6-12.	Introduction.....	6-2
6-14.	Specifications.....	6-2
6-15.	HIGH VOLTAGE PROBE (80K-40)	6-2
6-16.	Introduction.....	6-2
6-18.	Specifications.....	6-2
6-19.	HIGH FREQUENCY PROBE (81RF)	6-2
6-20.	Introduction	6-2
6-22.	Specifications.....	6-2
7	SCHEMATIC DIAGRAMS	7-1
	SERVICE CENTERS	7-3
	SERVICE REPORT	7-5
	WARRANTY	
	APPENDIX A - Manual Change Information	

List of Illustrations

FIGURE	TITLE	PAGE
1-1.	Controls, Indicators, Connectors.....	1-2
2-1.	Recommended Method for Removing Battery Cover	2-1
2-2.	Waveform Conversion	2-4
2-3.	Voltage Measurement Error Calculations (Loading Error).....	2-4
2-4.	Current Measurement Error Calculations (Burden Voltage Error).....	2-5
2-5.	Conductance-to-Resistance Conversion Scales and Interpolation Table	2-6
2-6.	Selecting a Range and Function.....	2-6
2-7.	Transistor Beta Test Fixture.....	2-7
3-1.	8020A Simplified Block Diagram	3-1
3-2.	Dual-Slope A/D Converter.....	3-3
3-3.	Input Signal Conditioners	3-4
4-1.	Calibration Adjustment Locations	4-2
5-1.	8020A PCB Assembly.....	5-3
6-1.	8020A Accessories.....	6-1

List of Tables

TABLE	TITLE	PAGE
1-1.	Controls, Indicators, Connectors.	1-3
1-2.	8020A Specifications	1-4
2-1.	Summary of Input Overload Limits.	2-3
2-2.	Resistance Ranges and Their Voltage/Current Capability.	2-3
4-1.	List of Recommended Test Equipment	4-1
4-2.	Resistance/Conductance Checks.	4-4
4-3.	DC Voltage Checks	4-4
4-4.	AC Voltage Checks.	4-4
4-5.	DC Current (mA) Checks	4-5
4-6.	Troubleshooting Guide.	4-6

Section 1

Introduction & Specifications

1-1. INTRODUCTION

1-2. The Fluke Model 8020A is a portable 3½-digit, pocket-sized multimeter that is ideally suited for field, lab, shop, bench, or home applications. It weighs in at an impressive 369 grams (13 ounces) with battery, and packs more measurement power than the heavy-weights. Here's a review of some of the features that qualify the 8020A as a real pro:

- All VOM functions plus the versatile conductance function (six in all) are included as standard.
 - DC Voltage — 100 μ V to 1000V
 - AC Voltage — 100 μ V to 750V
 - DC Current — 1 μ A to 2000 mA
 - AC Current — 1 μ A to 2000 mA
 - Resistance — 0.1 Ω to 20 M Ω
 - Conductance — 0.1 nS to 200 nS and .001 mS to 2 mS (S = siemens = 1/ Ω).
- CONDUCTANCE!! A new multimeter function that allows fast, accurate, noise free resistance measurements up to 10,000 M Ω .
- The latest IC and display technology is used to achieve the lowest possible component count. This, in turn, ensures reliability, accuracy, stability and a really rugged, easy-to-handle instrument.
- Up to 200 hours of continuous operation can be expected from a single, inexpensive, 9V, alkaline battery (transistor radio/calculator type).
- Low battery voltage automatically detected and displayed.
- No needles to bend. No parallax and no zero adjust. Just a high contrast, easy-to-read, 3-1/2 digit, liquid crystal display.
- Line operation is possible using a Model A81 Battery Eliminator (See Section 6, accessories).
- Effective overload and transient protection on all ranges.
- Overrange indication on each range.
- Long term calibration (1 year) is achieved by using high stability components, and minimizing adjustments (three total).
- Full auto-polarity operation.
- Dual slope integration to ensure fast, accurate, noise free measurements.
- A complete line of range extending accessories is available.

1-3. PREPARING FOR OPERATION**1-4. Unpacking**

1-5. When received, the 8020A shipping carton should contain the items listed below. Account for, and inspect each item before the carton is discarded. In the event of a damaged instrument, contact your nearest John Fluke Service Center as listed at the rear of this manual. Please retain and use the shipping container if reshipment is required.

Contents:

- 1 — Model 8020A Multimeter
- 1 — Model 8020A Instruction Manual
- 1 — 9V Battery
- 1 — Set of Test Leads (red and black)
- 1 — 8020A Operator's Guide (plastic card)
- X — Accessories as ordered

1-6. Battery Installation

WARNING

BATTERY OR FUSE INSTALLATION/REPLACEMENT SHOULD ONLY BE PERFORMED AFTER THE INPUT SIGNAL AND THE TEST LEADS HAVE BEEN REMOVED FROM THE INPUT TERMINALS, AND THE POWER SWITCH IS SET TO OFF.

1-7. To install the battery, locate the battery-compartment cover on the bottom of the 8020A, and using both thumbs slide it away from the case screw to expose the battery compartment. See Figure 2-1. Then, extend the battery-clip and cable from the compartment, and attach the 9V battery (supplied with the 8020A). While the cable is extended, check the fuse-clip on the back of the battery-clip. It should contain an AGX 2 (2A/250V) fuse (a metric fuse, type 171100-2, is supplied with units having white and white/red wires going to the fuse clip). Carefully position the battery, cable, and clip within the confines of the battery compartment by inserting cable first, followed by fuse-end of battery assembly. Finally, close the compartment by sliding the cover into position

CAUTION

If fuse replacement is necessary, do not substitute fuse type or rating, for metric fuse clips use type 171100-2. Otherwise use AGX2.

1-8. GETTING ACQUAINTED

1-9. Before attempting to use your 8020A, we suggest that you take a few minutes to get acquainted. First, let's find out what all the buttons are for. Then we'll check it out to make sure it's working properly.

1-10. Physical Features

1-11. All of the buttons, switches, and other externally accessible physical features of the 8020A are shown in Figure 1-1 and described in Table 1-1. Locate each of the features on your instrument as you read the functional description.

1-12. Initial Check-Out Procedure

1-13. Now that you have installed the battery, and know where everything is, let's make sure the unit is working properly. We'll run through a simple check-out

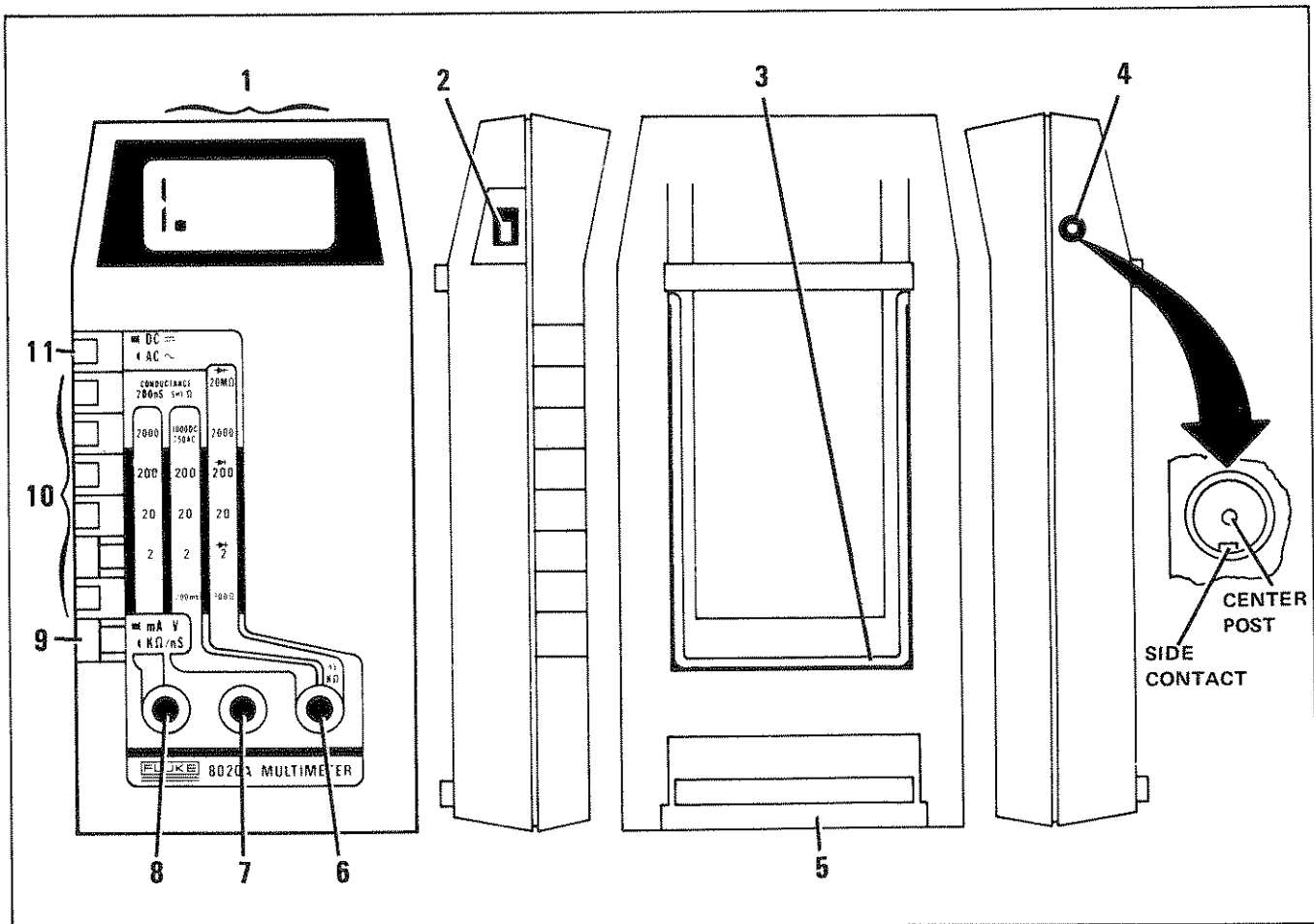

Figure 1-1. Controls, Indicators, Connectors

Table 1-1. Controls, Indicators, Connectors

ITEM NO.	NAME	FUNCTION
1	Display	A 3½ digit display (1999 max) with decimal point and minus polarity indication. Used to indicate measured input values, overrange condition and low battery condition.
2	Power Switch	A slide switch used to turn the instrument off and on.
3	Tilt Bail	A removable fold-out stand which allows the instrument to be either tilted for bench-top applications or hung from a hook in the absence of a work surface.
4	Battery Eliminator Connector	An external input power connector for use with the Model A81 Battery Eliminator accessory. (A81 is available in a variety of voltage and plug configurations. See Section 6).
5	Battery Compartment and Cover	Cover for the 9V battery and the current-protection fuse. The cover is removed by pushing it away from the case screw.
6	V/KΩ Input Connector	Banana jack connector used as the high input for all voltage, resistance and conductance measurements.
7	COMMON Input Connector	Banana jack connector used as the low or common input for all measurements.
8	mA Input Connector	Banana jack connector used as the high input for all current measurements.
9	mA/V-KΩ/nS Switch	A push-push switch (push on - push off, do not pull to select function) which operates in conjunction with the high input connectors to select either the mA/V or kΩ (conductance) measurement functions. When in or depressed it selects kΩ. The out position selects mA or V depending upon the location of the high input lead.
10	Range Switches	Interlocked push-button switches for selecting ranges, i.e., pressing the desired range switch selects that range and cancels previous switch depressions. Do not pull switches to select a range. Voltage: 200 mV, 2V, 20V, 200V, 1000V dc/750V ac Current: 2 mA, 20 mA, 200 mA, 2000 mA Resistance: 200Ω, 2 kΩ, 20 kΩ, 200 kΩ, 2000 kΩ, 20 MΩ Conductance: 200 nS or 2 mS (S = siemens = 1/Ω = international unit of conductance). Requires simultaneous depression of two range switches.
11	DC/AC Switch	A push-push switch (push on - push off, do not pull to select function) used to select the ac or dc measurement function when measuring current or voltage. When in, or depressed, the ac function is selected. Out selects dc. Switch may be in either position when making resistance or conductance measurements.

procedure starting with turn-on. No equipment other than the test leads will be required. If a problem is encountered, please recheck the battery, fuse, switch settings, and test lead connections before contacting your nearest authorized John Fluke Service Center.

NOTE

This procedure is intended to verify overall instrument operation, and is not meant as a substitute for the formal Performance Test given in Section 4. Limits shown exceed the specifications because the procedure uses one measurement function to check another.

- a. Set the power switch to OFF and all range and function switches to the released (out) position.
- b. Set the power switch to ON and observe the display. It should read 00.0 ± 0.1 .
- c. Connect the red test lead to the V/KΩ input terminal.
- d. Touch the red probe tip to the COMMON input terminal, and sequentially depress each of the six grey range switches starting at the top (20 MΩ). The display should read zero \pm one digit and the decimal point should be positioned as follows:

1. 20 MΩ — 0.00
 2. 2000 kΩ — 000
 3. 200 kΩ — 00.0
 4. 20 kΩ — 0.00
 5. 2 kΩ — .000
 6. 200Ω — 00.0
- e. Press the 20V range switch and remove the probe from the COMMON input terminal.
 - f. Look inside of the battery eliminator connector on the right side of the 8020A and locate the connector contacts (center post and side contact as shown in Figure 1-1).
 - g. Touch the red probe tip to the center post of the battery eliminator connector. The display should read approximately -6.1 (V dc)
 - h. Touch the probe tip to the side contact of the battery eliminator connector. The display should read approximately 2.9 (V dc). Notice that the sum of the two readings is equal to the battery voltage (typically, 8 to 10V dc). Remove the probe from the battery jack.
 - i. Depress the lower white button (KΩ) and sequentially depress each of the six range switches. The display should read 1 as the most significant digit with no other numbers shown. This is the standard overrange indication. Notice that the decimal point changes position with the range switch settings just as it did in step d of this procedure.
 - j. Touch the red probe tip to the COMMON input terminal, and sequentially press each of the grey buttons. The display should read zero at each range setting. Lead resistance may be sufficient to cause a one or two tenths (0.1 or 0.2Ω) indication on the 200Ω range.
 - k. Touch the red probe tip to the mA input connector and press the 200Ω switch. The display should read 99.0 to 101.0.
 - l. Press the 2 KΩ switch. The display should read .099 to .101. Remove the probe from the mA input connector.
 - m. Simultaneously depress the 2000 KΩ and the 20 MΩ range switches. This selects the 200 nS range. The display should read 00.0 to 01.0 (minimum conductance, maximum resistance).
 - n. Touch the red probe tip to the COMMON input connector. An overrange indication should be displayed since conductance is the reciprocal of resistance.
 - o. Connect the black test lead to the COMMON input connector.
 - p. Depress both the AC/DC switch and the 750V ac range switch. Set the mA/V-KΩ switch to the voltage (out) position.

WARNING

THE LOCAL LINE VOLTAGE IS MEASURED IN THE FOLLOWING STEP. BE CAREFUL NOT TO TOUCH THE PROBE TIPS WITH FINGERS, OR TO ALLOW THE PROBE TIPS TO CONTACT EACH OTHER.

- q. Measure the local ac line voltage at a convenient output receptacle. The voltage should be displayed with 1 volt resolution.
- r. If the 8020A has responded properly to this point, it is operational and ready for use.

1-14. SPECIFICATIONS

1-15. Detailed specifications for the Model 8020A are given in Table 1-2.

Table 1-2. 8020A Specifications

ELECTRICAL	The electrical specifications given assume an operating temperature of 18°C to 28°C, humidity up to 90%, and a 1-year calibration cycle.
FUNCTIONS	DC Volts, AC Volts, DC Current, AC Current, Resistance and Conductance.
DC VOLTS	
Ranges	±200 mV, ±2V, ±20V, ±200V, ±1000V
Accuracy	±(0.25% of reading +1 digit), all ranges
Input Impedance	10 MΩ, all ranges
Normal Mode Rejection Ratio	60 dB at 60 Hz or 60 dB at 50 Hz.
Common Mode Rejection Ratio	100 dB at dc, 50 Hz and 60 Hz
Overvoltage Protection	1000V dc or peak ac on all ranges

Table 1-2. 8020A Specifications (Continued)

AC VOLTS

Ranges 200 mV, 2V, 20V, 200V, 750 rms
 Accuracy See table

RANGE	45 Hz to 1 kHz	1 kHz to 2 kHz	2 kHz to 5 kHz
200 mV	±(0.75% of reading +2 digits)	±(1.5% of reading +3 digits)	±(5% of reading +5 digits)
2V			
20V			
200V			
750V	±(1% of reading +2 digits)		

Input Impedance 10 M Ω , capacitance <100 pF, all ranges

Overvoltage Protection 1000V dc or 750V rms max or 10⁷ volt-Hertz (whichever is less).
 200 mV range; 15 seconds max over 300V ac.

RESISTANCE

Ranges 200 Ω , 2k Ω , 20 k Ω , 200 k Ω , 2000 k Ω , 20 M Ω

Accuracy

2k Ω , 20k Ω , 200k Ω , 2000k Ω ±(0.2% of reading +1 digit)

200 Ω ±(0.3% of reading +3 digits)

20 M Ω ±(2.0% of reading +1 digit)

Full Scale Voltage

200 Ω , 20 k Ω , 2000 k Ω <0.25V dc (in-circuit ohms)

200 k Ω , 20 M Ω >0.7V dc } (diode test )

2 k Ω >1.0V dc }

Open Circuit Voltage

2 k Ω <3.5V dc

All other ranges <1.5V dc

Diode Test Ranges

200 Ω , 20 k Ω , 2000 k Ω Typical silicon junction will **not** be turned-on by these ranges.

2 k Ω , 200 k Ω , 20 M Ω Typical silicon junction will be turned-on by these ranges. The 2 k Ω range will supply a typical forward current of 0.6 mA, and is preferred for testing semiconductor junctions (marked )

Overvoltage Protection 300V dc or rms, on all ranges.

CONDUCTANCE

Ranges 2 mS, 200 nS

Accuracy

2 mS ±(0.3% of reading +1 digit)

200 nS ±(2.0% of reading +10 digits)

Table 1-2. 8020A Specifications (Concluded)

Open-Circuit Voltage	
2mS	<3.5V
200nS	<1.5V
Diode Test	Both ranges will forward bias a typical silicon PN junction.
Overload Protection	300V dc/rms on all ranges.
DC CURRENT	
Ranges	± 2 mA, ± 20 mA, ± 200 mA, ± 2000 mA
Accuracy	$\pm(0.75\%$ of reading +1 digit), all ranges
Burden Voltage	
2 mA to 200 mA Ranges	0.25V dc max at full scale
2000 mA Range	0.7V dc max at full scale
Overcurrent Protection	2 amps max on all ranges. Fuse protected when measuring current in circuits with open-circuit voltage of 250V or less.
AC CURRENT SPECIFICATIONS	
Ranges	2 mA, 20 mA, 200 mA, 2000 mA
Accuracy	
2 mA (45 Hz to 450 Hz)	$\pm(2\%$ of reading +2 digits)
20 mA, 200 mA, 2000 mA	$\pm(1.5\%$ of reading +2 digits)
(45 Hz to 1 kHz)	
Burden Voltage	
2 mA to 200 mA Ranges	0.25V rms max at full scale
2000 mA Range	0.7V rms max at full scale
Overcurrent Protection	2 amps max on all ranges. Fuse protected when measuring current in circuits with open-circuit voltage of 250V or less.
ENVIRONMENTAL	
TEMPERATURE COEFFICIENT	Less than 0.1 times the applicable accuracy specification, per °C (0° to 18°C and 28° to 50°C)
OPERATING TEMPERATURE	0° to 50°C
STORAGE TEMPERATURE	-35° to 60°C
HUMIDITY	0 to 90% at 0°C to 35°C, 0 to 80% at 0°C to 35°C on 2M Ω , 20M Ω and 200nS ranges. 0 to 70% at 35°C to 50°C
GENERAL	
MAXIMUM COMMON MODE VOLTAGE	500V dc/rms ac
POWER	9V alkaline or carbon-zinc battery (NEDA 1604), or accessory battery eliminator Fluke Model A-81.
Battery Life, Typical	Alkaline 200 hours, carbon-zinc 100 to 150 hours
Battery Indicator	Display reads BT when battery voltage drops below 7.2 volts, typically. Approximately 20% of battery life remains.
Battery Eliminator	Fluke Model A-81. Available as an accessory. Specify local line voltage.
WEIGHT	369 grams/13 ounces (with battery)
SIZE	4.5 x 8.6 x 18.0 cm (H x W x L) 1.8 x 3.4 x 7.1 inches (H x W x L)

Section 2

Operating Instructions

2-1. INTRODUCTION

2-2. To fully utilize the measurement capabilities of the 8020A, a basic understanding of its measurement techniques and limitations is required. This section of the manual provides that information, plus a few applications that may prove useful. For example, did you know your 8020A will provide direct-reading dc current gain (beta) measurements for both NPN and PNP transistors? If you'll take time to read this section of the manual, we'll show you how its done.

2-3. OPERATING NOTES

2-4. The following paragraphs are intended to familiarize the operator with the capabilities and limitations of the 8020A, and to instruct him in routine operator's maintenance such as fuse and battery replacement.

2-5. Input Power

2-6. BATTERY LIFE

2-7. The 8020A is designed to operate on a single, inexpensive 9V battery of the transistor radio/calculator variety (NEDA 1604). If an alkaline battery is used, a typical operating life of up to 200 hours can be expected. Carbon-zinc batteries will have a useful life of up to 150 hours. In either event the 8020A will display a BT (in upper left-hand corner) when the battery has exhausted approximately 80% of its useful life. When BT first appears, the battery is capable of properly operating the 8020A for at least another 20 hours.

NOTE

To ensure operation within the accuracy specifications, the battery should be replaced when the voltage measured at the center of the battery eliminator connector falls below-3.00 volts (with respect to the COMMON input).

2-8. BATTERY INSTALLATION/REPLACEMENT

WARNING

BATTERY REPLACEMENT SHOULD ONLY BE PERFORMED AFTER THE INPUT SIGNAL AND TEST LEADS HAVE BEEN REMOVED FROM THE INPUT TERMINALS, AND THE POWER SWITCH IS SET TO OFF.

- 2-9. Use the following procedure to install or replace the battery:
- a. Set the 8020A power switch to OFF.
 - b. Remove test leads from external circuit connections and from the 8020A input terminals.
 - c. Open the battery compartment on the bottom of the 8020A using the method shown in Figure 2-1.

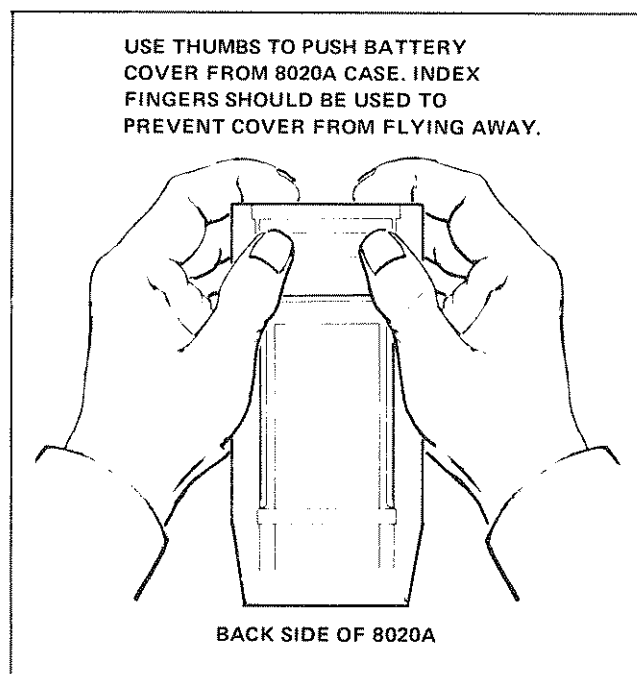

Figure 2-1. Recommended Method of Removing Battery Cover

- d. Extend the battery by sliding it toward the connector end until it can be tilted out.
- e. Carefully pull the battery clip free from the battery terminals.
- f. Press the battery clip onto the replacement battery and return both to the battery compartment.
- g. Make sure the battery and its leads are fully within the confines of the battery compartment before sliding the cover into place.

WARNING

DO NOT OPERATE THE 8020A UNTIL THE BATTERY COVER IS IN PLACE AND FULLY CLOSED.

2-10. BATTERY ELIMINATOR

2-11. A line-powered battery eliminator (Model A81) is available as an accessory, and is described in Section 6 of this manual. When the A81 is used, the battery is automatically disconnected to conserve battery life. The A81 connects to the 8020A through a recessed, side-panel jack.

2-12. Display Readings*NOTE*

The liquid crystal display used in the 8020A is a rugged and reliable unit which will give years of satisfactory service. Display life can be extended by observing the following practices:

1. *Protect the display from extended exposure to bright sunlight.*
2. *Keep the voltmeter out of high temperature, high humidity environments, such as, the dash of a car on a hot sunny day, otherwise the display may temporarily turn black. Recovery occurs at normal operating temperature. (Also, the numbers become sluggish at extremely cold temperatures).*

2-13. The front panel display provides a continuous indication of the 8020A's operating status. That is, low battery, overload, and normal operation. A "BT" is displayed when approximately 80% of the battery's life is exhausted (battery replacement is indicated). And, a "1" followed by three blanked digits is displayed (decimal point may be present) as an overrange indication. This does not necessarily mean that the instrument is being

exposed to a damaging input condition. For example, when measuring resistance an open-input will cause an overrange indication.

NOTE

When the 8020A is powered with the A81 Battery Eliminator the "BT" indicator may come on due to low line voltage. However, instrument operation will be normal.

2-14. Normal operation is indicated by an on-scale display complete with polarity and decimal point, when required. The position of the decimal point is determined by the selected range, and is not affected by the measurement function. Polarity, on the other hand, is only used for the dc voltage and current measurement functions. A minus sign indicates that the input signal is negative with respect to the COMMON input terminal. Positive inputs are indicated by the absence of the minus sign.

NOTE

The minus sign (-) may flash momentarily as the 8020A comes out of an overrange condition. This will most likely be seen in the ohms mode as the open circuit test leads are applied to an in-range resistance value. If the minus sign remains on for in-range ohms readings, the circuit is live (a negative voltage is present at the input terminals due to charged capacitors, etc.) and incorrect resistance readings will be observed.

2-15. Input Connections to COMMON**WARNING**

TO AVOID ELECTRICAL SHOCK AND/OR INSTRUMENT DAMAGE DO NOT CONNECT THE COMMON INPUT TERMINAL TO ANY SOURCE OF MORE THAN 500 VOLTS ABOVE EARTH GROUND.

2-16. The 8020A may be operated with the COMMON input terminal at a potential of up to 500V dc or V ac above earth ground. If this limit is exceeded, instrument damage may occur. This, in turn, may result in a safety hazard for the operator.

2-17. Input Overload Protection**CAUTION**

Exceeding the maximum input overload limits can damage the 8020A.

2-18. Each measurement function and its associated ranges are equipped with input overload protection. The overload limits for each function and range are given in Table 2-1.

SELECTED FUNCTION	SELECTED RANGE	INPUT CONNECTIONS	MAX INPUT OVERLOAD
V dc or V ac	200 mV, 2V, 20V, 200V, 750V ac, 1000V dc	V/k Ω and COMMON	1000V dc or peak ac on dc ranges. 1000V dc or 750V rms on ac ranges-15 seconds max on 200 mV ac range.
mA dc or mA ac	2 mA, 20 mA, 200 mA, 2000 mA	mA and COMMON	2A max. Fuse protected in circuits with open circuit voltage \leq 250V dc/rms ac. Do not use above 250V.
Ω , k Ω M Ω , S (1/ Ω)	200 Ω , 2 k Ω , 20 k Ω , 200 k Ω , 2000 k Ω , 20 M Ω 200 nS, 2 mS	V/k Ω and COMMON	300V dc or rms.
ANY	ANY	COMMON	500V dc/rms ac with respect to earth ground

2-19. Fuse Replacement

2-20. The ac and dc current functions are fuse protected (on all ranges) from inadvertent application of current in excess of 2 amps. The fuse is located on the back of the battery clip and is accessed by removing the battery compartment cover. For replacement, use type AGX 2 (instruments that accommodate metric fuses use type 171100-2).

2-21. Use the following procedure to install or replace the fuse.

- Set the 8020A power switch to OFF.
- Remove test leads from external circuit connections and from the 8020A input terminals.
- Open the battery compartment on the bottom of the 8020A using the method shown in Figure 2-1.
- Extend the battery and fuse by sliding toward connector end and then tilting out of compartment.
- Carefully remove and replace the defective fuse.
- Return the battery and fuse to the battery compartment. Insert leads first, then connector. Tilt battery down into the compartment.

- Make sure the battery and its leads are fully within the confines of the battery compartment before closing the cover.

WARNING

DO NOT OPERATE THE 8020A UNTIL THE BATTERY COVER IS IN PLACE AND FULLY CLOSED.

2-22. AC Measurement

2-23. The ac ranges of the 8020A employ an average responding ac converter. This means that the unit measures the average value of the input, and displays it as an equivalent rms value for a sine wave. As a result, measurement errors are introduced when the input wave form is distorted (non sinusoidal). The amount of error depends upon the amount of distortion. Figure 2-2 shows the relationship between sine, square and triangular waveforms, and the required conversion factors.

2-24. Resistance

2-25. Six direct reading resistance scales are provided on the 8020A; 20 M Ω , 2000 k Ω , 200 k Ω , 20 k Ω , 2 k Ω and 200 Ω . All scales employ a two wire measurement technique. As a result, test lead resistance may influence measurement accuracy on the 200 Ω range. To determine the error, short the test leads together and read the lead resistance. Correct the measurement by subtracting the lead resistance from the unknown reading. The error is generally on the order of 0.2 to 0.3 ohms for a standard pair of test leads.

2-26. In-circuit resistance measurements can be made using the 200 Ω , 20 k Ω and 2000 k Ω ranges. The open circuit measurement voltage produced on these ranges is not sufficient to forward bias silicon diode/emitter-base junctions, and thus, enables resistance values to be measured without removing diodes and transistors from the circuit. Conversely, the 2 k Ω , 200 k Ω and 20 M Ω ranges produce a measurement voltage sufficient to forward bias a P-N junction. These ranges enable both diode- and transistor-junction checks to be made conveniently. Maximum open circuit voltage and short circuit current for each resistance range is given in Table 2-2. All values shown are referenced to the COMMON input terminal; i.e., the V/K Ω terminal is positive.

Table 2-2. Resistance Range and Their Voltage/Current Capability

Range	Full Scale Voltage (Typical)	Short Circuit Current (Typical)
20 M Ω	+800MV	+0.12 μ A
2000k Ω	+200MV	+0.12 μ A
200k Ω	+800MV	+0.12mA
20 k Ω	+200MV	+0.12mA
2 k Ω	+1.1 V	+1.0mA
200 Ω	+55MV	+0.3mA





INPUT WAVEFORM	DISPLAY MULTIPLIER FOR MEASUREMENT CONVERSION			
	PK-PK	0-PK	RMS	AVG
SINE 	2.828	1.414	1.000	0.900
RECTIFIED SINE (FULL WAVE) 	1.414	1.414	1.000	0.900
RECTIFIED SINE (HALF WAVE) 	2.828	2.828	1.414	0.900
SQUARE 	1.800	0.900	0.900	0.900
RECTIFIED SQUARE 	1.800	1.800	1.272	0.900
RECTANGULAR PULSE $D = X/Y$ 	0.9/D	0.9/D	$0.9D^{1/2}$	0.9D
TRIANGLE SAWTOOTH 	3.600	1.800	1.038	0.900

Figure 2-2. Waveform Conversion

NOTE

Any change (greater than one or two digits) in apparent resistance when test leads are reversed may indicate either the presence of a diode junction or a voltage in the circuit.

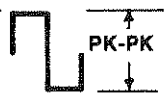
CAUTION

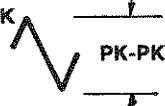
Turn test circuit power off and discharge all capacitors before attempting in-circuit resistance measurements.

2-27. Voltage AC/DC

2-28. The 8020A is equipped with five ac and five dc voltage ranges; 200 mV, 2V, 20V, 200V, 750V ac/1000V

dc. All ranges present an input impedance of 10 MΩ. On the ac ranges this is shunted by less than 100 pF. When making measurements, be careful not to exceed the overload limits given earlier in Table 2-1.

2-29. Measurement errors, due to circuit loading, can result when making either ac or dc voltage measurements on circuits with high source resistance. However, in most cases the error is negligible ($\leq 0.1\%$) as long as the source resistance of the measurement circuit is 10 kΩ or less. If circuit loading does present a problem, the percentage of error can be calculated using the appropriate formula in Figure 2-3.

1. DC VOLTAGE MEASUREMENTS

Loading Error in % = $100 \times R_s \div (R_s + 10^7)$
 Where: R_s = Source resistance in ohms of circuit being measured.

2. AC VOLTAGE MEASUREMENTS

First, determine input impedance, as follows:

$$Z_{in} = \frac{10^7}{\sqrt{1 + (2\pi F \cdot R_{in} \cdot C)^2}}$$

Where: Z_{in} = effective input impedance
 R_{in} = 10^7 ohms
 C_{in} = 100×10^{-12} Farads
 F = frequency in Hz

Then, determine source loading error as follows:

$$\text{Loading Error in \%} = 100 \times \frac{Z_s}{R_s + Z_{in}}$$

Where: Z_s = source impedance
 Z_{in} = input impedance (calculated)
 R_s = source resistance

Figure 2-3. Voltage Measurement Error Calculations (Loading Error)

NOTE

Noise rejection is optimized (≈ 60 dB) when the 8020A is operated in its normal line-frequency environment, i.e., 50 or 60 Hz. Units designed for 50 Hz environments are identified by a "50/" preceding the serial number. Units without the "50/" are 60 Hz models. If operation in both environments is anticipated, the 50 Hz model is preferred since it provides ≈ 60 dB rejection at both frequencies on all voltage and current ranges.

2-30. Current AC/DC

2-31. Four ac and four dc current ranges are included on the 8020A; 2 mA, 20 mA, 200 mA and 2000 mA. Each range is diode protected to 2 amps and fuse

protected above 2 amps. If the fuse blows, refer to fuse replacement information given earlier in this section.

2-31a. In high electrical noise environments (near ignition systems, fluorescent lights, relay switches, etc.) unstable or erroneous readings (exceeding specifications) may occur. The effect is most obvious when measuring low level current on the 2 mA range. If an erratic or erroneous reading is suspected, temporarily jumper the V/k Ω /nS connector to the mA connector. This will ensure an accurate measurement.

CAUTION

To avoid possible instrument damage and/or erroneous measurements remove the temporary V/k Ω /nS-to-mA jumper before attempting voltage or resistance measurements.

WARNING

Instrument damage and operator injury may result if the fuse blows while current is being measured in a circuit which exhibits an open circuit voltage >250 volts. To prevent this possibility, place a suitable mounted and insulated 1.5A fuse of the proper voltage rating (>250V) in series with the high (mA) input lead.

2-32. Full scale burden voltage (voltage drop across the fuse and current shunt) for all ranges except 2000 mA is less than 250 mV. The 2000 mA range has a full scale burden voltage of less than 700 mV. These voltage drops can affect the accuracy of a current measurement, if the current source is unregulated and the shunt plus fuse resistance represents a significant portion (1/1000 or more) of the source resistance. If burden voltage does present a problem, the percentage of error can be calculated using the formula in Figure 2-4. This error can be minimized by using the highest current range that gives the necessary resolution. For example, if 20 mA is measured on the 2000 mA range the burden voltage is approximately 5 mV.

2-33. Conductance

2-34. The conductance ranges, 200 nS and 2 mS, are included on the 8020A for making both conductance and resistance measurements. When either range is selected the display reads the measurement results in terms of conductance (1/ Ω). If resistance readings are required, refer to the conductance-to-resistance conversion information given in Figure 2-5.

2-35. The 200 nS range is intended for use in making fast, accurate, high-resistance measurements from 5 M Ω

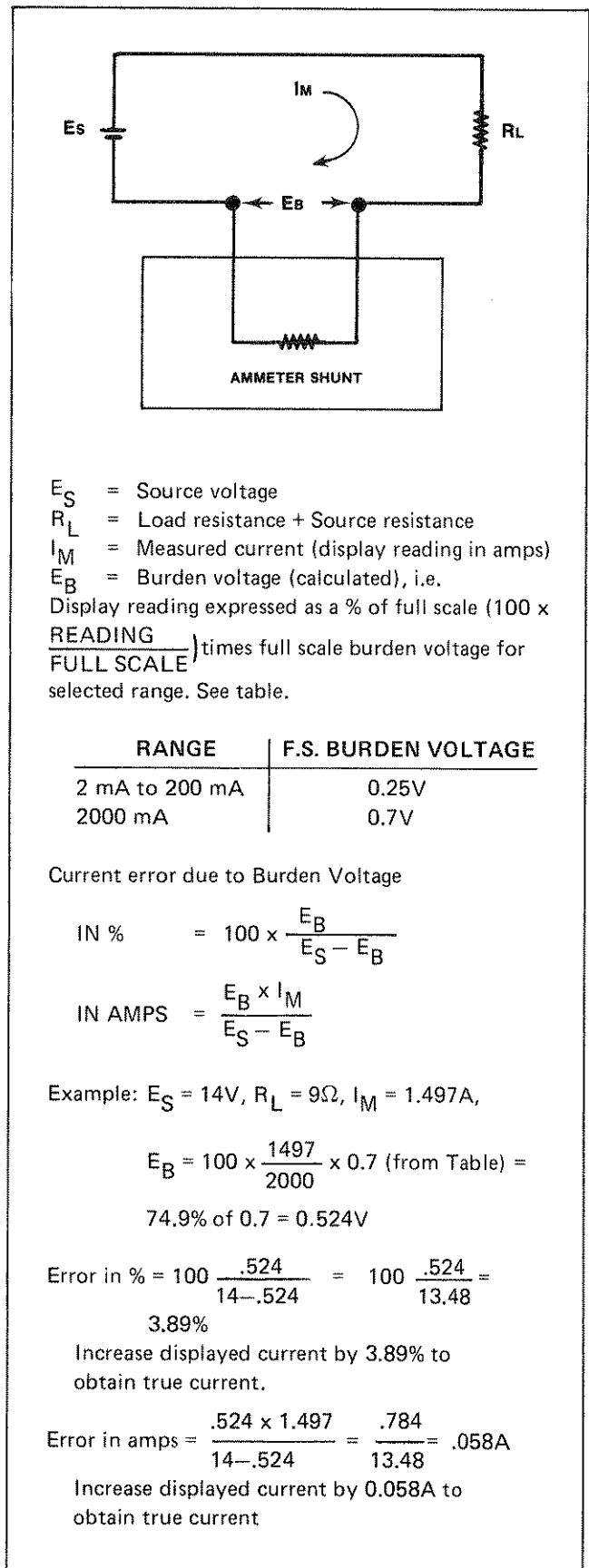

Figure 2-4. Current Measurement Error Calculations

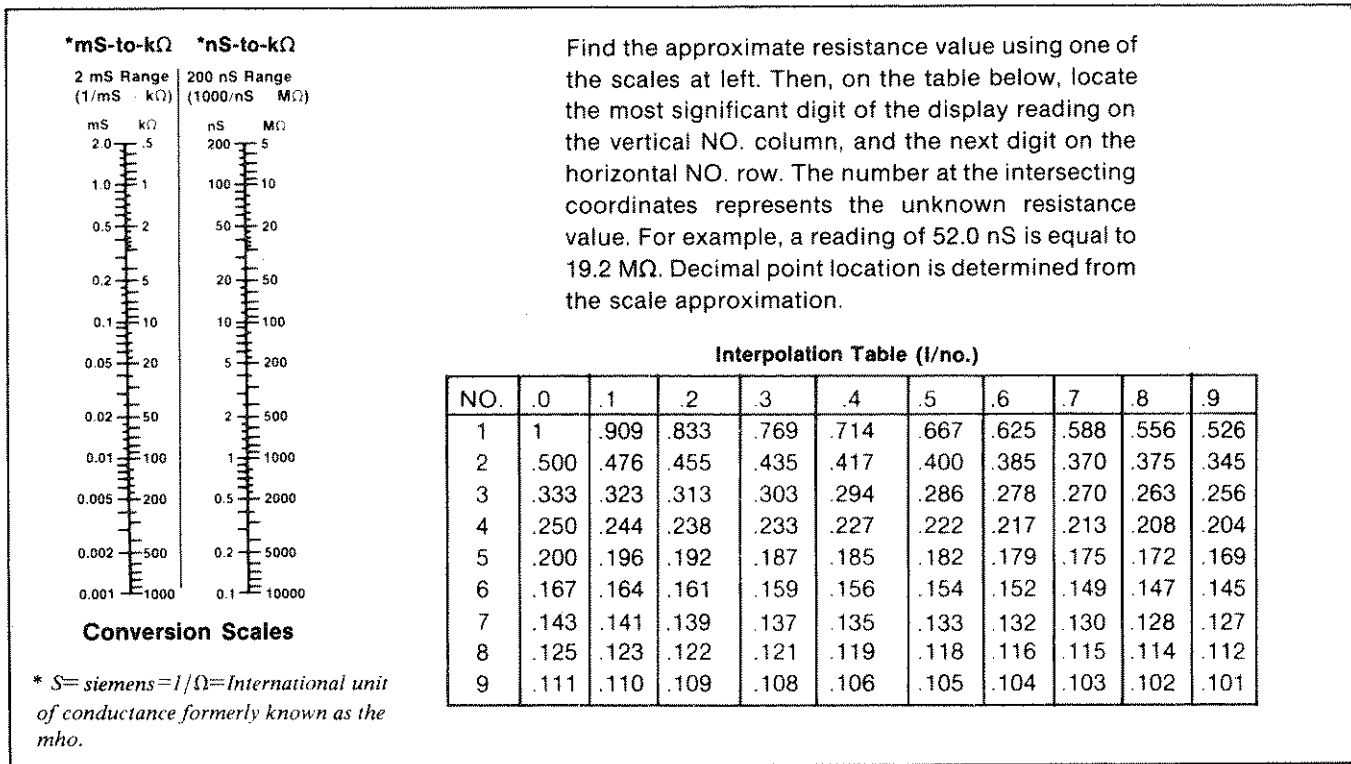

Figure 2-5.
Conductance-to-Resistance Conversion Scales and Interpolation Table

to 10,000 MΩ. Ordinarily, resistance measurements within this range are plagued by noise pick-up and require careful shielding. However, by measuring the resistance in terms of conductance, common test leads are adequate for the 8020A to make noise-free measurements clear up to 10,000 MΩ. High value resistors, and low leakage components (i.e., capacitors, diodes, etc.) are natural candidates for the 200 nS conductance range. Refer to applications later in this section for additional information.

2-36. The 2 ms range, in terms of resistance, starts at 500Ω and goes up to 1 MΩ. It is intended for use in making either resistance measurements or direct-reading dc current gain (beta) measurements on transistors. Beta measurements require the use of a special test fixture, and are discussed later in this section under applications.

2-37. OPERATION

2-38. Operation of the 8020A is an easy four step process:

- a. Set the power switch to ON.
- b. With reference to Figure 2-6, set the range and function switches for the desired measurement.
- c. Connect the test leads to the appropriate input terminals. See Figure 2-6.
- d. Contact the input signal and read the display.

2-39. APPLICATIONS

2-40. The test applications described in the following paragraphs are suggested as useful extensions of the 8020A measurement capabilities. However, they are not intended as the equivalent of manufacturer's recommended test methods. But rather, are intended to provide repeatable and meaningful indications which will allow the operator to make sound judgements concerning the condition of the device tested; i.e., good, marginal, or defective.

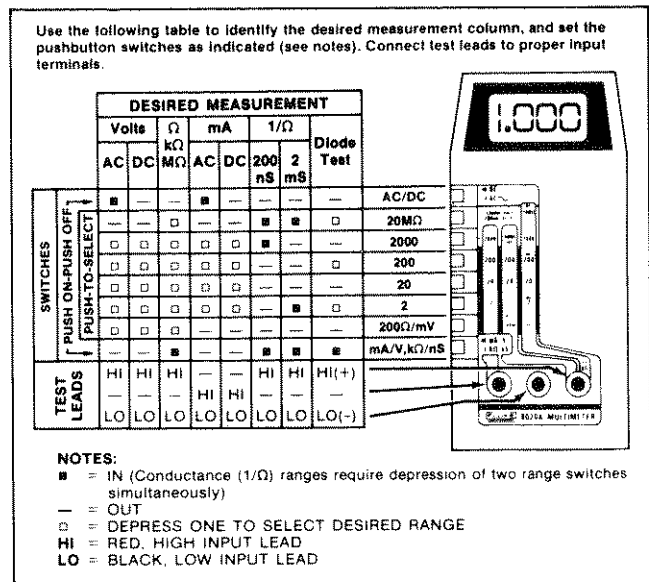

Figure 2-6. Selecting a Function and Range

2-41. Transistor Tester

NOTE

The transistor tester described in the following paragraphs provides approximate test information. Beta is measured using a VCE of about 2V and an IC of about 200 μA. It is very useful for comparative measurements and matching.

2-42. Select the 2 mS range, plug the fixture shown in Figure 2-7 into the V/KΩ and COMMON input terminals, and you have transformed your 8020A into a transistor tester. Now, plug a transistor into the test socket and the 8020A will determine the following:

- a. Transistor type (NPN or PNP).
- b. Collector-to-emitter leakage (ICEs).
- c. Beta from 1 to 1000 without changing range.

2-43. Transistor type is determined by setting the switch on the fixture to BETA and observing the display. If a very low reading (≤ 0.010) is obtained, reverse the test fixture at the input terminals. If the collector is now positioned at the COMMON input terminal, the transistor is a PNP type. An NPN type will have its collector positioned at the V/kΩ input terminals. If the transistor is defective the indications will be as follows regardless of fixture position:

- a. A shorted transistor will cause an overload indication.
- b. An open transistor will read 0.001 or less.

2-44. After the transistor fixture is properly positioned, set the switch to ICEs for the leakage test. The transistor is turned off in this test (base shorted to emitter), and should appear as a very low conductance (high resistance) from collector-to-emitter. Therefore, the lower the reading, the lower the leakage. Silicon transistors that read more than 0.002 (6 μA) should be considered questionable.

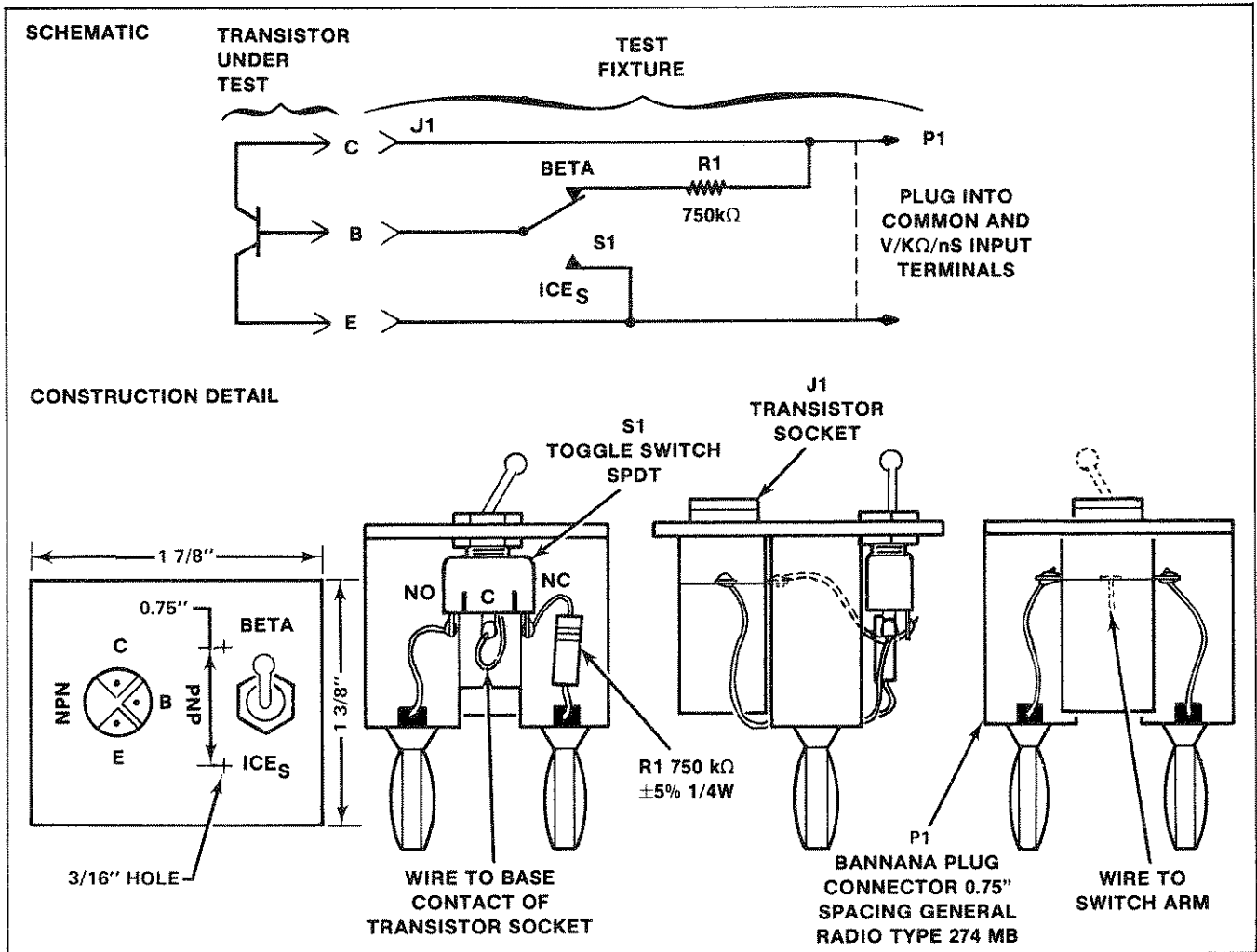

Figure 2-7. Transistor Beta Test Fixture

2-45. Beta is determined by setting the fixture switch to BETA, and observing the display. Mentally shift the decimal point three places to the right and read beta directly. For example, a display reading of 0.127 indicates a dc current gain (beta) of 127.

NOTE

Beta is a temperature sensitive parameter. Therefore, repeatable readings can only be obtained by allowing the transistor to stabilize at the ambient temperature while being tested. Avoid touching the transistor's case with your fingers.

2-46. Leakage Tester

2-47. The 200 nS conductance range effectively extends the resistance measurement capability of the 8020A (up to 10,000 M Ω) to the point where it can be used to provide useful leakage measurements on passive components. For example, you can detect leaky capacitors, diodes, cables, connectors, printed circuit boards (pcb's), etc. In all cases the test voltage is <5V dc.

2-48. RESISTIVE COMPONENTS

2-49. Leakage testing on purely resistive components such as cables and pcb's is straight forward. Select the 200 nS range, install the test leads in the V/K Ω and COMMON input terminals, connect the leads to the desired test points on the unit-under-test, and read leakage conductance. If an overrange occurs, select the resistance range that provides an on-scale reading.

NOTE

Under high humidity conditions (>80%) conductance measurements may be in error. To ensure accurate measurements connect clean test leads to the 8020A and (with the

leads open) read the residual leakage in nanosiemens. Correct subsequent measurements by subtracting this residual from the readings. (Finger prints or other contamination on the pcb may also cause residual conductance readings).

2-50. DIODES

2-51. Diode leakage (I_R) tests require that the diode junction be reversed biased when being measured. This is accomplished by connecting the diode's anode to the COMMON input terminal and its cathode to the V/K Ω input terminal. Leakage can then be read in terms of conductance. In the event of an overrange, select a resistance range that provides an on-scale reading.

2-52. CAPACITORS

2-53. Capacitor leakage measurements are easily accomplished using the following procedure.

- a. Disconnect the capacitor from its circuit.
- b. Discharge the capacitor using a 100 Ω resistor.
- c. If the capacitor is polarity sensitive (electrolytic, etc.), identify the positive side and connect it to the 8020A's V/k Ω input. Connect the negative side to COMMON. Non-polarized capacitors can be connected either way.
- d. Select the 200 Ω range and allow the capacitor to assume a charge (charge time is about 5 seconds or 10 seconds/100 μ F, whichever is greater).
- e. Select the 200 nS range and allow the reading to stabilize. This may take a while for larger capacitors. However, devices below 1 μ F stabilize rapidly.
- f. Read the leakage in terms of conductance. Overrange readings indicate a short or excessive leakage.

Section 3

Theory of Operation

3-1. INTRODUCTION

3-2. This section of the manual contains an overall functional description followed by a block diagram analysis of the 8020A. A detailed schematic of the 8020A appears in Section 7.

3-3. OVERALL FUNCTIONAL DESCRIPTION

3-4. The Model 8020A, as shown in Figure 3-1, is a hand-held six function digital multimeter. It features a total of 26 measurement ranges (V dc, 5; V ac, 5; ohms, 6; conductance, 2; mA dc, 4; and mA ac, 4), a high

contrast easy-to-read, 3-1/2 digit, liquid crystal display; long battery life (up to 200 hours); overload protection for all ranges; and a minimum of components.

3-5. Operation centers around a custom LSI chip, U8, which comprises a dual slope a/d converter and a display driver. Peripherals to U8 include range and function switches, input signal conditioners, and the display. When an input signal is applied to the 8020A, it is routed through the range switches to one-of-four input signal conditioners as determined by the function switch setting. Each conditioner scales and, if necessary, rectifies the input so that an acceptable dc input level (-0.2 to $+0.2$ V dc) is presented to the a/d converter.

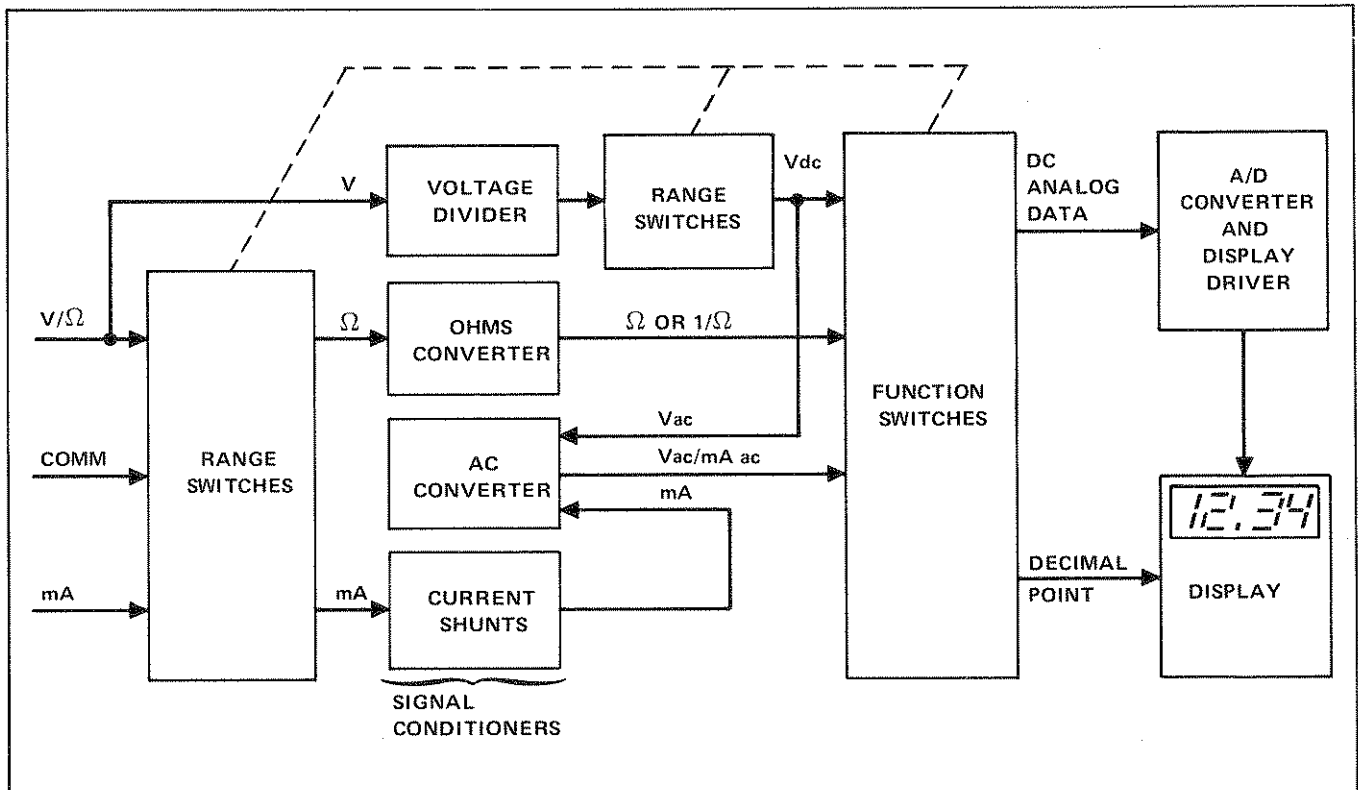

Figure 3-1. 8020A Simplified Block Diagram

3-6. Timing for the overall operation of the a/d converter is derived from an external quartz crystal whose frequency is selected to be a multiple of the local line frequency. This allows the conditioned dc input data to be intergrated over a single line cycle, thus, optimizing both common mode and normal mode rejection.

3-7. Digitized measurement data is presented to the display as four decoded digits (seven segments) plus polarity. Decimal point position on the display is determined by the range switch settings.

3-8. BLOCK DIAGRAM ANALYSIS

3-9. A/D Converter

3-10. The entire analog-to-digital conversion process is accomplished by a single custom a/d converter and Display Driver IC, U8. The IC employs the dual slope method of a/d conversion, and requires a series of external components to establish the basic timing and reference levels required for operation. These include a 3.2 MHz crystal, an integrating capacitor, an autozero capacitor, and a flying capacitor (for applying a reference level of either polarity). Since the power consumed for display operation is very low, the a/d converter IC also contains the display latches, decoders and drivers.

3-11. The digital control portion of the a/d conversion process is an internal function of U8, and is keyed to the external crystal frequency. As a result, the conversion process is continuously repeated, and the display is updated at the end of the every conversion cycle.

3-12. A simplified circuit diagram of the analog portion of the a/d converter is shown in Figure 3-2. Each of the switches shown represent analog gates which are operated by the digital section of the a/d converter. Basic timing for switch operation and, therefore, a complete measurement cycle is also included in the figure.

3-13. Any given measurement cycle performed by the a/d converter can be divided into three consecutive time periods, autozero (AZ), integrate (INTEG), and read. Both autozero and integrate are fixed time periods whose lengths are multiples of a 60 kHz clock. A counter

determines the length of both time periods by providing an overflow at the end of every 10,000 clock pulses. The read period is a variable time which is proportional to the unknown input voltage. The value of the voltage is determined by counting the number of clock pulses that occur during the read period.

3-14. During autozero a ground reference is applied as an input to the a/d converter. Under ideal conditions the output of the comparator would also go to zero. However, input-offset-voltage errors accumulate in the amplifier loop, and appear at the comparator output as an error voltage. This error is impressed across the AZ capacitor where it is stored for the remainder of the measurement cycle. The stored level is used to provide offset voltage correction during the integrate and read periods.

3-15. The integrate period begins at the end of the autozero period. As the period begins, the AZ switch opens and the INTEG switch closes. This applies the unknown input voltage to the input of the a/d converter. The voltage is buffered and passed on to the integrator to determine the charge rate (slope) on the INTEG capacitor. At the end of the fixed integrate period the capacitor is charged to a level proportional to the unknown input voltage. This voltage is translated to a digital indication by discharging the capacitor at a fixed rate during the read period, and counting the number of clock pulses that occur before it returns to the original autozero level.

3-16. As the read period begins, the INTEG switch opens and the read switch closes. This applies a known reference voltage to the input of the a/d converter. The polarity of this voltage is automatically selected to be opposite that of the unknown input voltage, thus, causing the INTEG capacitor to discharge at a fixed rate (slope). When the charge is equal to the initial starting point (autozero level), the read period is ended. Since the discharge slope is fixed during the read period, the time required for discharge is proportional to the unknown input voltage.

3-17. The autozero period and, thus, a new measurement cycle begins at the end of the read period. At the same time the counter is released for operation by transferring its contents (previous measurement value) to a series of latches. This stored data is then decoded and buffered before being used for driving the liquid crystal display.

3-18. Input Signal Conditioners

3-19. The a/d converter requires two externally supplied input voltages to complete a measurement cycle.

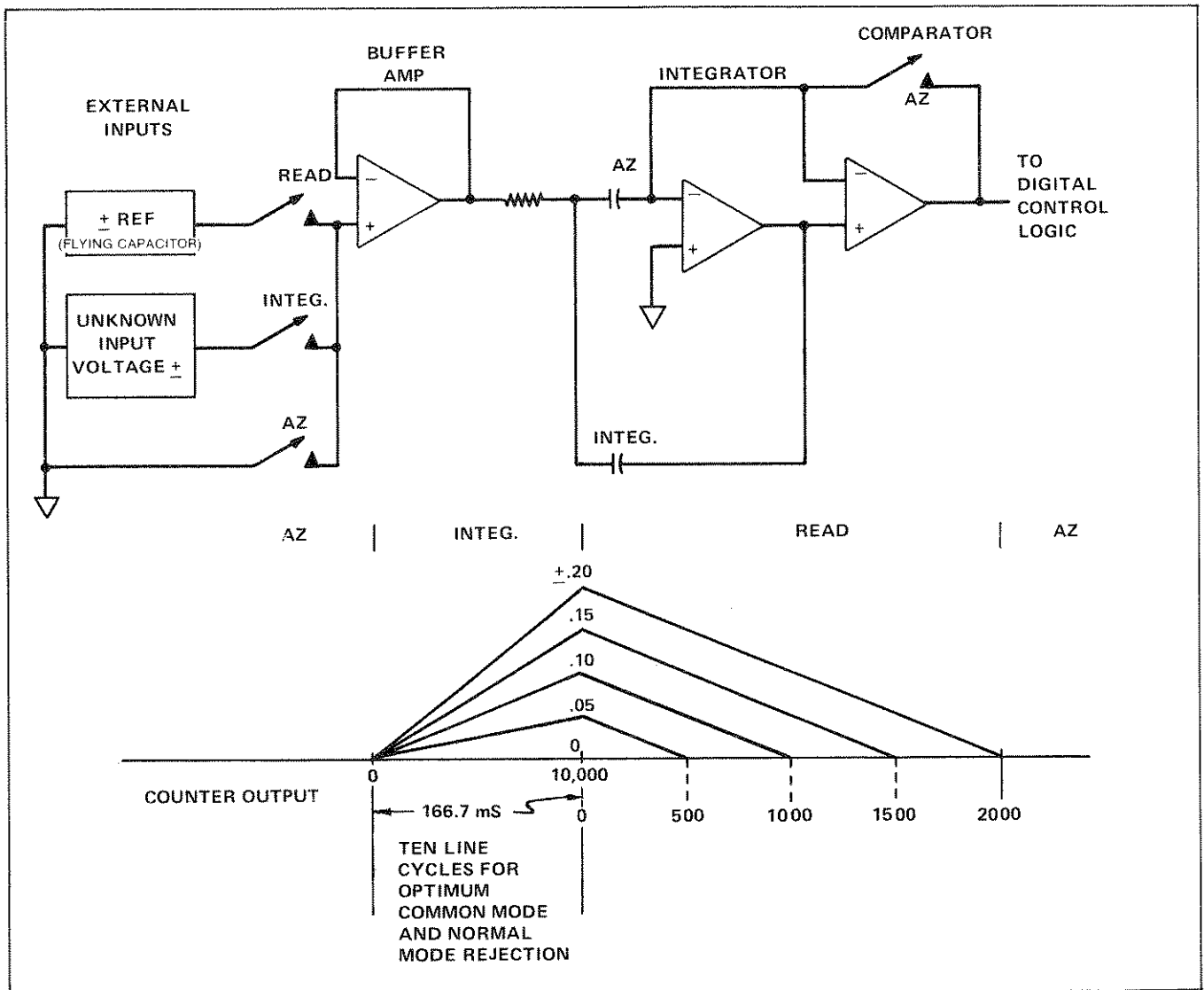

Figure 3-2. Dual Slope A/D Converter

One is a reference voltage and the other is an unknown dc voltage within the range of -0.2 to $+0.2$ V dc. If the function being measured is other than a dc voltage within the ± 0.2 V range, it must be scaled and/or conditioned before being presented to the a/d converter. For example, higher dc levels must be divided; ac inputs must be divided, rectified, and filtered; and resistance, conductance and current inputs must be scaled and converted to dc voltage levels. The following paragraphs describe the input signal conditioners used for each of the 8020A measurement functions.

3-20. VOLTAGE MEASUREMENTS

3-21. Both the ac and dc voltage ranges use an over-voltage-protected, $10\text{ M}\Omega$ input divider as shown in Figure 3-3A. Under normal conditions, assuming a dc input level on the proper range, the divider output is a -0.2 to $+0.2$ V dc signal, and is an exact (power-of-10) ratio of the input signal. If the VAC function is selected,

the divider output is ac coupled to an active full-wave rectifier whose dc output is calibrated to equal the rms level of the ac inputs. The conditioned signal for the selected function (V ac or V dc) is then passed through a filter before being presented to the a/d converter as the unknown input.

3-22. CURRENT MEASUREMENT

3-23. Current measurements are made using a fuse protected, switchable, four-terminal current shunt (0.1Ω , 1Ω , 10Ω or 100Ω) to perform the current-to-voltage conversion required by the a/d converter. See Figure 3-3B. The voltage ($I \cdot R$) drops produced across the selected shunt may be either ac or dc depending upon the selected function, mA AC or mA DC. If the input current is dc and the dc function is selected, the $I \cdot R$ drop is passed through a low-pass filter, and presented as the unknown input to the a/d converter. However, if the

input current is ac and the AC function is selected, the $I \cdot R$ drop is rectified by the ac converter before going to the low-pass filter. In either event the a/d converter receives a dc input voltage proportional to the current passing through the selected shunt.

3-24. RESISTANCE MEASUREMENTS

3-25. Resistance measurements are made using a ratio technique as shown in Figure 3-3C. When the $k\Omega$ function is selected a simple series circuit is formed by the internal reference voltage, a reference resistor from the voltage divider (selected by range switches), and the external unknown resistor. The ratio of the two resistors is equal to the ratio of their respective voltage drops. Therefore, since the value of one resistor is known, the value of the second can be determined by using the voltage drop across the known resistor as a reference. This determination is made directly by the a/d converter.

3-26. Overall operation of the a/d converter during a resistance measurement is basically as described earlier in this section, with one exception. The reference voltage

present during a voltage measurement is replaced by the voltage drop across the reference resistor. This allows the voltage across the unknown resistor to be read during the integrate period, and compared against the reference resistor during the read period. As before, the length of the read period is a direct indication of the value of the unknown.

3-27. CONDUCTANCE MEASUREMENTS

3-28. Conductance measurements are made using a ratio technique similar to that used in making resistance measurements. See Figure 3-3C. The main difference is that only two ranges are provided (200 nS and 2 mS), and the function of the range and unknown resistors in the measurement cycle is reversed. That is, the voltage drop across the range resistor is used as the unknown input during the integrate period, and the voltage across the unknown resistor is used for the reference input during the read period. As a result the display provides a reading that is the reciprocal ($1/\Omega$) of the unknown input resistance, i.e., the higher the input resistance the lower the display reading.

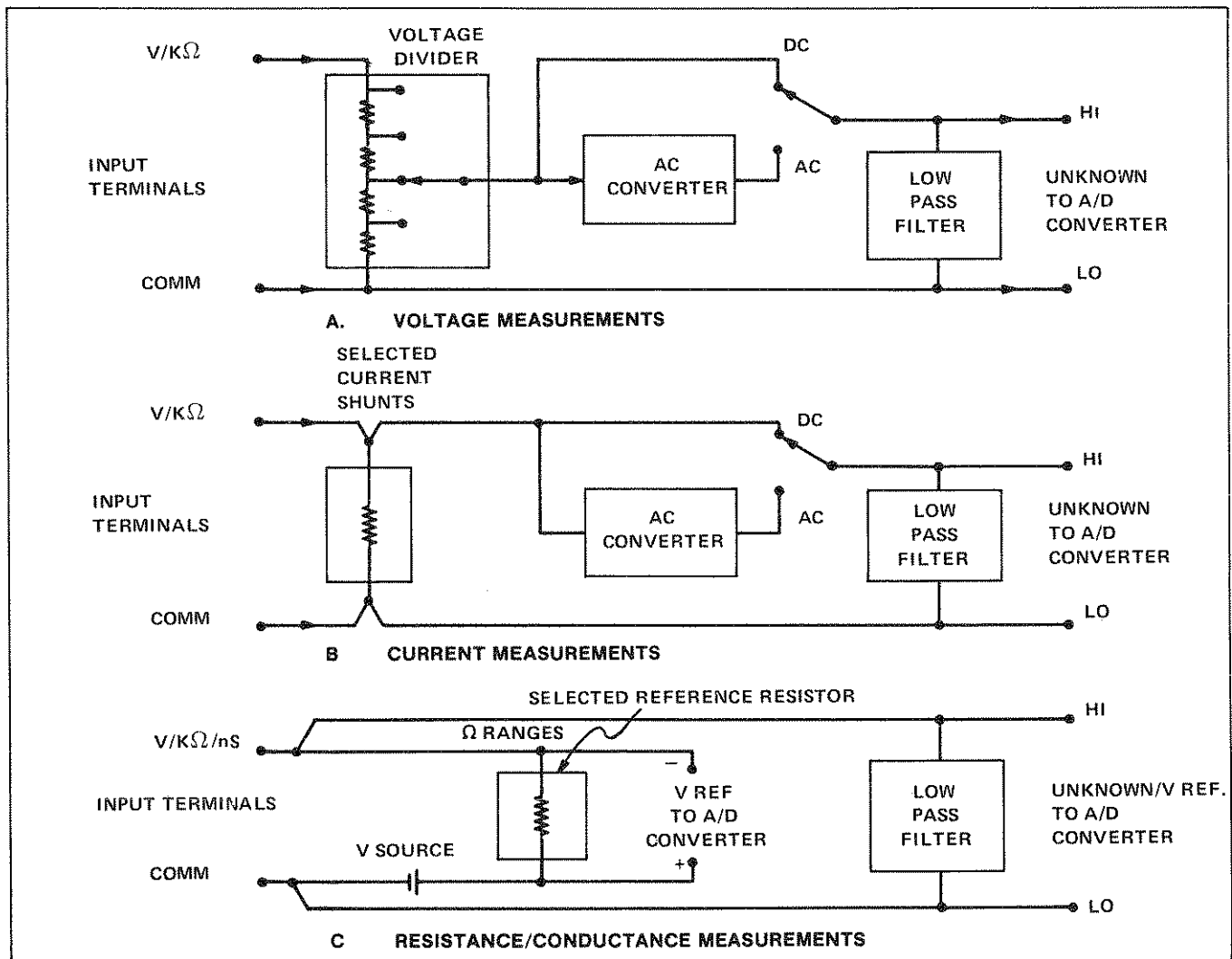

Figure 3-3. Input Signal Conditioners

Section 4

Maintenance

WARNING!

THESE SERVICING INSTRUCTIONS ARE FOR USE BY QUALIFIED PERSONNEL ONLY. TO AVOID ELECTRIC SHOCK, DO NOT PERFORM ANY SERVICING OTHER THAN THAT CONTAINED IN THE OPERATING INSTRUCTIONS UNLESS YOU ARE QUALIFIED TO DO SO.

4-1. INTRODUCTION

4-2. This section of the manual contains maintenance information for the Model 8020A. This includes service information, general maintenance, performance test, calibration and troubleshooting. The performance test is recommended as an acceptance test when the unit is first received, and later as a preventive maintenance tool to verify proper instrument operation. A 1-year calibration cycle is recommended to maintain the specifications given in Section 1 of this manual. The test equipment required for both the performance test and calibration is listed in Table 4-1. If the recommended equipment is not available, instruments having equivalent specifications may be used.

4-3. SERVICE INFORMATION

4-4. The 8020A is warranted for a period of 1-year upon delivery to the original purchaser. Conditions of

the warranty are given at the rear of this manual.

4-5. Malfunctions that occur within the limits of the warranty will be corrected at no charge. Simply mail the instrument (post paid) to your nearest authorized (in-warranty) Fluke Technical Service Center. Shipping information, address labels, packing slip, and a complete list of service centers are provided at the rear of this manual. Dated proof-of-purchase will be required for all in-warranty repairs.

4-6. Factory authorized service centers are also available for calibration and/or repair of instruments that are beyond their warranty period. Contact your nearest authorized Fluke Technical Service Center for a cost quotation. Ship instrument and remittance using the instructions given at the end of this manual.

Table 4-1. List of Recommended Equipment

INSTRUMENT TYPE	REQUIRED CHARACTERISTICS	RECOMMENDED MODEL
AC Calibrator	Voltage Range: 0 to 750V ac Frequency Range: 100 to 5 kHz: $\pm 0.25\%$ Voltage Accuracy, 100 to 1 kHz: $\pm 0.1\%$	John Fluke Model 5200A and 5205A
DC Calibrator	Voltage Range: 0 to 1000V dc Accuracy: $\pm 0.025\%$	John Fluke Model 343A
DC Current Calibrator	Current Range: 2 mA to 2A Accuracy: $\pm 0.2\%$	John Fluke Model 382A
Resistor Decade or Individual Resistors	Resistance Values: 190 Ω , 1.9 k Ω , 19 k Ω , 190 k Ω , 1.9 M Ω , and 10 M Ω Accuracy: $\pm 0.05\%$ Power Rating: $\geq 1/8$ watt	ESI Model DB62

4-7. GENERAL INFORMATION

4-8. Access Information

NOTE

To avoid contaminating the pcb with oil from the fingers, handle it by the edges or wear gloves. If the pcb does become contaminated refer to the cleaning procedure given later in this section.

4-9. CALIBRATION ACCESS

4-10. Use the following procedure to access the 8020A calibration adjustments.

- a. Set the power switch to OFF.
- b. Disconnect test leads and battery eliminator if attached.
- c. Remove battery cover and battery from compartment.
- d. Remove the three phillips-head screws from the bottom of the case.
- e. Turn the instrument face-up and grasp the top cover at both sides of the input connectors. Then, pull the top cover from the unit.
- f. All adjustments necessary to complete the calibration procedure are now accessible (see Figure 4-1).

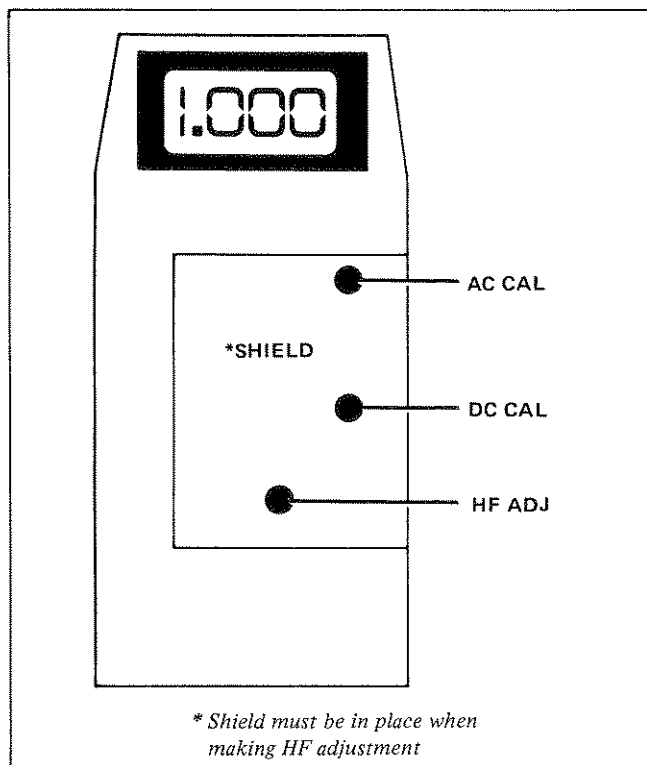

Figure 4-1. Calibration Adjustment Locations

4-11. COMPONENT/PCB ACCESS

4-12. Use the following procedure to remove the main pcb assembly from the case.

- a. Complete the calibration access procedure.
- b. Remove screw from shield.
- c. Using your index finger, lift the lower right-hand corner of the pcb. When the pcb is freed, pull it to the right until it clears the shelf under the buttons, and then lift up.
- d. To reassemble logically reverse this procedure.

NOTE

When installing pcb, route battery-clip wires behind the post on the left-hand side of bottom case, and thread battery-clip through the battery-cover opening. Also make sure that the removable plastic lip that resides beneath the range switch pushbuttons is properly installed in the bottom case. Green power switch cap should also be mounted on the power switch.

4-13. DISPLAY ACCESS

4-14. Use the following procedure to remove/replace the liquid crystal display.

- a. Remove the pcb assembly using the component/pcb access procedure.
- b. Using your thumb carefully pull one of the white display-lens snaps away from the lens. When clear lift the lens away from the display.

CAUTION

Do not slide the lens out of the display mount. This will scratch the lens.

- c. The display can now be lifted from the mount.
- d. To reassemble the display logically reverse this procedure.

NOTE

An Elastometric contact strip is located at the top of the liquid crystal display. See Figure 5-1. When assembling the display this strip should be located between the display and the pcb interconnect cable.

4-15. LSI (U8) ACCESS

4-16. Use the following procedure to remove/replace the A/D Converter and Display Driver IC, U8.

- a. Remove the pcb assembly using the component/pcb access procedure.
- b. On the bottom of the pcb locate and remove the two phillips head screws from the display assembly.
- c. Lift the display assembly from the pcb to expose U8.



CAUTION

U8 is a MOS device and is subject to damage by static discharge. Observe the precautions given later in this section under troubleshooting before attempting to remove or replace U8.

- d. Use a screw driver or a reasonable substitute to rock (by prying up on each end of the IC) the IC out of its socket.
- e. When installing U8 make sure all pins are lined up in the socket, and then carefully press it into place.
- f. When re-installing the LCD Bracket be sure to line up the flex cable holes with the extensions on the bracket before tightening the bracket screws.

4-17. Cleaning

CAUTION

Do not use aromatic hydrocarbons or chlorinated solvents for cleaning. These solutions will react with the plastic materials used in the instrument.

CAUTION

Do not get the liquid crystal display wet. Remove the display Assembly before washing the pcb and do not install it until the pcb has been fully dried.

4-18. Clean the front panel and case with a mild solution of detergent and water. Clean dust from the circuit board with low pressure (<20 psi) dry air. Contaminates can be removed from the circuit board with demineralized water and a soft brush (remove the Display assembly before washing, and avoid getting excessive amounts of water on the switches). Dry with clean dry air at low pressure, and then bake at 50 to 60° C for 24 hours.

4-19. Battery/Fuse Replacement

WARNING

BATTERY/FUSE REPLACEMENT SHOULD ONLY BE PERFORMED AFTER THE TEST LEADS HAVE BEEN REMOVED FROM THE INPUT JACKS, AND THE POWER SWITCH IS SET TO OFF.

4-20. Refer to Section 2 of this manual for battery and fuse replacement procedure. Use only the recommended replacement types.

4-21. PERFORMANCE TEST

4-22. The performance test is used to compare the 8020A performance with the list of specifications given in Section 1 of this manual. It is recommended for incoming inspection, periodic maintenance, and to verify specifications. If the instrument fails any part of the test, calibration and/or repair is indicated.

4-23. Initial Procedure

4-24. Each of the individual procedures that comprise the performance test assume that the following conditions exist.

- a. The unit has been allowed to stabilize and will be tested at an ambient temperature of $23 \pm 5^{\circ}\text{C}$ ($73 \pm 9^{\circ}\text{F}$).
- b. The fuse and battery have been checked and, if necessary, replaced.
- c. The power switch has been set to ON.

4-25. Display Test

4-26. The following procedure is used to test the operation of all display digits and segments.

- a. Select the 20 k Ω range. The display should be blanked with the exception of the overrange indicator (1) in the left hand column and a decimal point in the center of the display.
- b. Connect a decade resistor between the V K Ω and COMMON input terminals.
- c. Set the decade resistor to 10 k Ω and verify a display of 10.00 \pm 3 digits.
- d. Sequentially increase the resistance in 1.11 k Ω steps and verify the operation of each digit and its segments.
- e. Disconnect the decade resistor at the input terminals, and select the 2000 k Ω range. A decimal point should not be displayed.

- f. Sequentially select the 200, 20 and 2 k Ω range. The decimal point should appear in the tenths, hundredths and thousandths position, respectively.

4-27. Resistance/Conductance Test

4-28. The operation and accuracy of the resistance and conductance ranges are tested in the following procedure.

- Connect the decade resistor between the V/K Ω and COMMON input terminals.
- Refer to Table 4-2, and select the range and input conditions specified in step 1. Verify that the display reading is within the limits shown.
- Execute and verify steps 2 through 10 of Table 4-2 using the procedure described in step b.

Table 4-2. Resistance/Conductance Checks

STEP	RANGE	INPUT RESISTANCE	DISPLAY READING
1	200 Ω	Short	00.0 to 00.2
2	2 k Ω	Short	00.0 to 00.1
3	200 Ω	190 Ω	189.1 to 190.9
4	2 k Ω	1.9 k Ω	1.895 to 1.905
5	20 k Ω	19 k Ω	18.95 to 19.05
6	200 k Ω	190 k Ω	189.5 to 190.5
7	2000 k Ω	1900 k Ω	1895 to 1905
8	20 M Ω	10 M Ω	9.80 to 10.20
9	200 nS	10 M Ω	97.0 to 103.0
10	200 nS	Open	01.0 to 00.0

4-29. DC Voltage Test

4-30. Use the following procedure to check the accuracy and overall operation of the dc voltage ranges.

WARNING

CONNECT THE GROUND/Common/LOW SIDE OF THE VOLTAGE CALIBRATOR TO COMMON ON THE 8020A.

- Set the dc voltage calibrator for a zero volt output.
- Connect the calibrator output to the V/K Ω and COMMON input terminals of the 8020A (calibrator ground/common/low to 8020A).
- With reference to Table 4-3 select the 8020A voltage range given in step 1, and set the calibrator output to the corresponding 8020A input voltage. Verify that the display reading is within the limits shown.

- Execute and verify steps 2 through 7 of Table 4-3 using the procedure described in step c.

Table 4-3. DC Voltage Checks

STEP	VOLTAGE RANGE	INPUT VOLTAGE, DC	DISPLAY READING
1	200 mV	+190.0 mV	189.4 to 190.6
2	200 mV	-190.0 mV	-189.4 to -190.6
3	2V	0.0V	-.001 to .001
4	2V	+1.9V	1.894 to 1.906
5	20V	+19V	18.94 to 19.06
6	200V	+190V	189.4 to 190.6
7	1000V	+1000V	997 to 1003

4-31. AC Voltage Test

4-32. The ac voltage ranges are checked for accuracy and operation using the following procedure.

WARNING

CONNECT THE GROUND/Common/LOW SIDE OF THE AC CALIBRATOR TO COMMON ON THE 8020A.

- Set the ac calibrator for a zero volt ac output.
- Connect the calibrator output to the V/K Ω and COMMON input terminals for the 8020A (calibrator ground/common/low to 8020A COMMON).
- With reference to Table 4-4 select the 8020A voltage range given in step 1, and set the calibrator output to the corresponding 8020A input voltage and frequency. Verify that the display reading is within the limits shown.
- Execute and verify steps 2 through 12 of Table 4-4 using the procedure described in step c.

Table 4-4. AC Voltage Checks

STEP	VOLTAGE RANGE	INPUT		DISPLAY READING
		VOLTAGE	FREQ.	
1	200 mV	Short	—	00.0 to 00.2
2	200 mV	190 mV	100 Hz	188.4 to 191.6
3	200 mV	19 mV	100 Hz	18.7 to 19.3
4	200 mV	190 mV	5 kHz	180.0 to 199.9
5	2V	1.9V	5 kHz	1.800 to 1.999
6	2V	1.9V	100 Hz	1.884 to 1.916
7	20V	19V	100 Hz	18.84 to 19.16
8	20V	19V	5 kHz	18.00 to 19.99
9	200V	190V	2 kHz	186.9 to 193.1
10	200V	190V	100 Hz	188.4 to 191.6
11	750V	750V	100 Hz	741 to 759
12	750V	750V	1 kHz	741 to 759

4-33. DC Current Test

4-34. The following procedure is used to check the operation and accuracy of the DC current ranges.

- a. Set the output of the dc current source to zero mA.
- b. Connect the output of the current source to the mA and COMMON input terminals on the 8020A.
- c. With reference to Table 4-5 select the 8020A current range indicated in step 1, and set the calibrator output to provide the corresponding 8020A input current. Verify that the display reading is within the limits shown.

Table 4-5. DC Current (mA) Checks

STEP	CURRENT RANGE	INPUT CURRENT, DC	DISPLAY READING
1	2 mA	+1.9 mA	1.885 to 1.915
2	20 mA	-19 mA	-18.85 to 19.15
3	200 mA	+190 mA	188.5 to 191.5
4	2000 mA	+1900 mA	1885 to 1915

- d. Execute and verify steps 2 through 4 of Table 4-5 using the procedure described in step c.

4-35. CALIBRATION

4-36. Under normal operating conditions the 8020A should be calibrated once a year to maintain the specifications given in Section 1 of this manual. If instrument repairs have been made or if the unit fails the performance test, immediate calibration is indicated. Equipment required for calibration is given in Table 4-1. If the necessary equipment is not available, your nearest authorized Fluke Technical Service Center will be happy to help. A list of these service centers, as well as shipping information, is given at the back of this manual.

4-37. Use the following procedure to calibrate the 8020A:

NOTE

This procedure assumes an ambient temperature of $23 \pm 2^\circ \text{C}$ (70 to 77°F) and a relative humidity of less than 80%. The temperature of the unit should be allowed to stabilize for at least 30 minutes before calibration begins.

- a. Remove the top cover from the 8020A using the access procedure given earlier in this section.
- b. Set the 8020A power switch to ON and select the 200 mV DC range.
- e. Set the output of the dc calibrator to +190.0 mV and connect it to the 8020A input terminals; + to V/K Ω , and - to COMMON.
- d. Adjust the DC CAL pot (R6), as shown in Figure 4-1, for a display of 190.0 or 190.1. (Use a plastic adjustment tool or a common plastic screw driver for all adjustments)
- e. Disconnect the dc calibrator from the 8020A input terminals.
- f. Select the 200 mV AC range on the 8020A.
- g. Set the output of the ac calibrator to 190 mV at 100 Hz, and connect it to the 8020A input terminals; V/K Ω and COMMON.
- h. Adjust the AC CAL pot (R4) for a display of 190.0 (an occasional flash of ± 1 digit is acceptable).
- i. Select the 2VAC range on the 8020A and set the ac calibrator output to 1.9V at 5 kHz.
- j. Adjust the HF ADJ (C1) for a display of 1.895 to 1.905.
- k. Execute the performance test given earlier to ensure that all fixed range resistors and other non-adjustable components are operating within their specified limits.

4-38. TROUBLESHOOTING



Static discharge can damage MOS components contained in the 8020A.

- 4-39. When troubleshooting or repairing the 8020A use the following precautions to prevent damage from static discharge:
- a. Never remove, install or otherwise connect or disconnect components without first turning the 8020A power switch to OFF.
 - b. Perform all repairs at a static-free work station.
 - c. Do not handle IC's or pcb by their connectors.

- d. Use static ground straps to discharge repair personnel.
- e. Use conductive foam to store replacement or removed IC's.
- f. Remove all plastic, vinyl and styrofoam products from the work area.
- g. Use a grounded soldering iron.

4-40. A troubleshooting guide for the 8020A is given in Table 4-6. To properly use the guide complete the performance test given earlier in this section and note any discrepancies. Then locate the heading of the procedure in question in the Test and Symptom column (Table 4-6). Under that heading isolate the symptom that approximates the observed malfunction. Possible causes are listed to the right of the selected symptom. Details necessary to isolate a particular cause can be derived from the theory of operation in Section 3 and the schematic diagram in Section 7.

Table 4-6. Troubleshooting Guide

TEST AND SYMPTOM	POSSIBLE CAUSE
INITIAL PROCEDURE	
BT is displayed when unit is turned on.	Low battery, Q2, U7, U8.
Display blank.	Dead battery, power switch, VR2 shorted, U8.
DISPLAY TEST	
One or more segments will not light through entire test.	Display interconnect, display, or A/D Converter U8.
Decade inoperative or one or more segments always lit.	U8.
Improper decimal point indication.	Range switches, U6, U7, or display. (Check signals at U7 to isolate).
Minus sign improperly displayed.	U8.
Display lit but does not respond to changes in input.	Reference VR1, crystal Y1, A/D Converter U8.
RESISTANCE/CONDUCTANCE TEST	
Displayed reading is out of tolerance on at least one but not all ranges.	Range resistor U1.
Readings are noisy on all ranges.	Thermistor Rt1.
Readings are out of tolerance on high ohms.	RV1, RV2, RV3, RV4 overheated from severe overload.
Residual reading with test leads open	PCB is contaminated (See cleaning procedure, Section 4).
DC VOLTAGE TEST	
Display reading is out of tolerance on 200 mV range.	Out of calibration (DC), Vref (VR1) in error, U5, U8, S1.
Readings are out of tolerance on all ranges except 200mV.	Range resistor U1, U2, U3.
AC VOLTAGE TEST	
Displayed reading is out of tolerance on 200 mV range.	Out of calibration (AC), AC converter defective.
2V range is out of tolerance with 1.9V, 5kHz input.	HF adjust (C1) out of calibration.
Readings out of tolerance on all ranges except 200mV.	U1.
DC CURRENT TEST	
Input does not affect display.	Fuse F1 open, CR1, CR2.
Displayed reading is out of tolerance on one or more ranges.	If 2000 mA and 200 mA ranges are okay U2 is defective. Otherwise U3 is defective.
CALIBRATION	
DC CAL pot at limit.	VR1, U5 or R6.
AC CAL pot at limit.	U4, CR5, CR6, R4, AR1, dc calibration.
HF adjust at limit.	S3D, U1, C1, shield not installed.

Section 5

List of Replaceable Parts

5-1. INTRODUCTION

5-2. This section contains an illustrated parts breakdown of the instrument. Components are listed alpha-numerically by assembly. Electrical components are listed by reference designation and mechanical components are listed by item number. Each listed part is shown in an accompanying illustration.

5-3. Parts lists include the following information:

- a. Reference Designation or Item Number.
- b. Description of each part.
- c. FLUKE Stock Number.
- d. Federal Supply Code for Manufacturers.
- e. Manufacturer's Part Number or Type.
- f. Total Quantity per assembly or component.
- g. Recommended Quantity: This entry indicates the recommended number of spare parts necessary to support one to five instruments for a period of two years. This list presumes an availability of common electronic parts at the maintenance site. For maintenance for one year or more at an isolated site, it is recommended that at least one of each assembly in the instrument be stocked. In the case of optional

subassemblies, plug-ins, etc. that are not always part of the instrument, or are deviations from the basic instrument model, the REC QTY column lists the recommended quantity of the item in that particular assembly.

- h. The Use Code column is not used.

5-4. HOW TO OBTAIN PARTS

5-5. Components may be ordered from the nearest Fluke authorized service center listed at the rear of this manual. To ensure prompt and efficient handling of your order, include the following information.

- a. Quantity.
- b. FLUKE Stock Number.
- c. Description.
- d. Reference Designation or Item Number.
- e. Printed Circuit Board Part Number.
- f. Instrument Model Number and the Rev. letter inked on pcb assembly.

CAUTION

Indicated devices are subject to damage by static discharge.

Table 5-1. 8020A Final and Case Assemblies





REF DESIG OR ITEM NO.	DESCRIPTION	FLUKE STOCK NO.	MFG FED SPLY CDE	MFG PART. NO. OR TYPE	TOT QTY	REC QTY	USE CDE
	MODEL 8020A FINAL ASSEMBLY	8020A					
A1	Case Assembly				1		
A3	8020A PCB Assembly	450783			1		
	Battery, 9V	446823	89536	NEDA1604	1		
	Button, power switch	456491	89536	456491	1		
	Instruction Manual, 8020A	459339	89536	459339	1		
	Operator's Guide, plastic	459347	89536	459347	1		
	Test Lead Set	484055	89536	484055	1		
	Screw, thread forming	447953	89536	447953	3		
	Screw, shield mounting	448456	89536	448456	1		
A1	CASE ASSEMBLY				REF		
	USA	457291	89536	457291			
	European	467365	89536	467365			
	Case, plastic, bottom				1		
	USA	450700	89536	450700			
	European	454587	89536	454587			
	Cover, battery	450718	89536	450718	1		
	Decal, warning	428938	89536	428938	1		
	Flange, switch	455881	89536	455881	1		
	Shield	453845	89536	453845	1		
	Tilt Bail	453043	89536	453043	1		
	Case, plastic, top	450692	89536	450692	1		
	Decal, front panel	453027	89536	453027	1		
	Spacer, case	458588	89536	458588	2		
	 Assembly is not procurable at this level.						

Table 5-2. 8020A PCB Assembly

REF DESIG OR ITEM NO.	DESCRIPTION	FLUKE STOCK NO.	MFG FED SPLY CDE	MFG PART. NO. OR TYPE	TOT QTY	REC QTY	USE CDE
A3	8020A PCB ASSEMBLY (8020A-4001) Figure 5-1	450783			REF		
A3A1	8020A PCB Subassembly	450791			1		
U8	IC, MOS, custom a/d converter and display driver	486464	89536	486464	1	1	
U9	IC, liquid crystal display, 3½ digits	453100	89536	453100	1	1	
1	Bracket, display (U9), mounting	450734	89536	450734	1		
2	Connector, elastomeric	453092	89536	453092	1		
3	Insert, rubber, display bracket	453787	89536	453787	2		
4	Interconnect, display-to-pcb	453746	89536	453746	1		
5	Lens, display, plastic	450759	89536	450759	1		
6	Pushbutton, white				2		
	If switch assy is milky clear, order	450809	89536	450809			
	If switch assy is blue, order	450957	89536	450957			
7	Pushbutton, grey				6		
	If switch assy is milky clear, order	450767	89536	450767			
	If switch assy is blue, order	459040	89536	459040			
8	Screw, display, thread-forming	448456	89536	448456	2		
	 Assembly is not procurable at this level.						

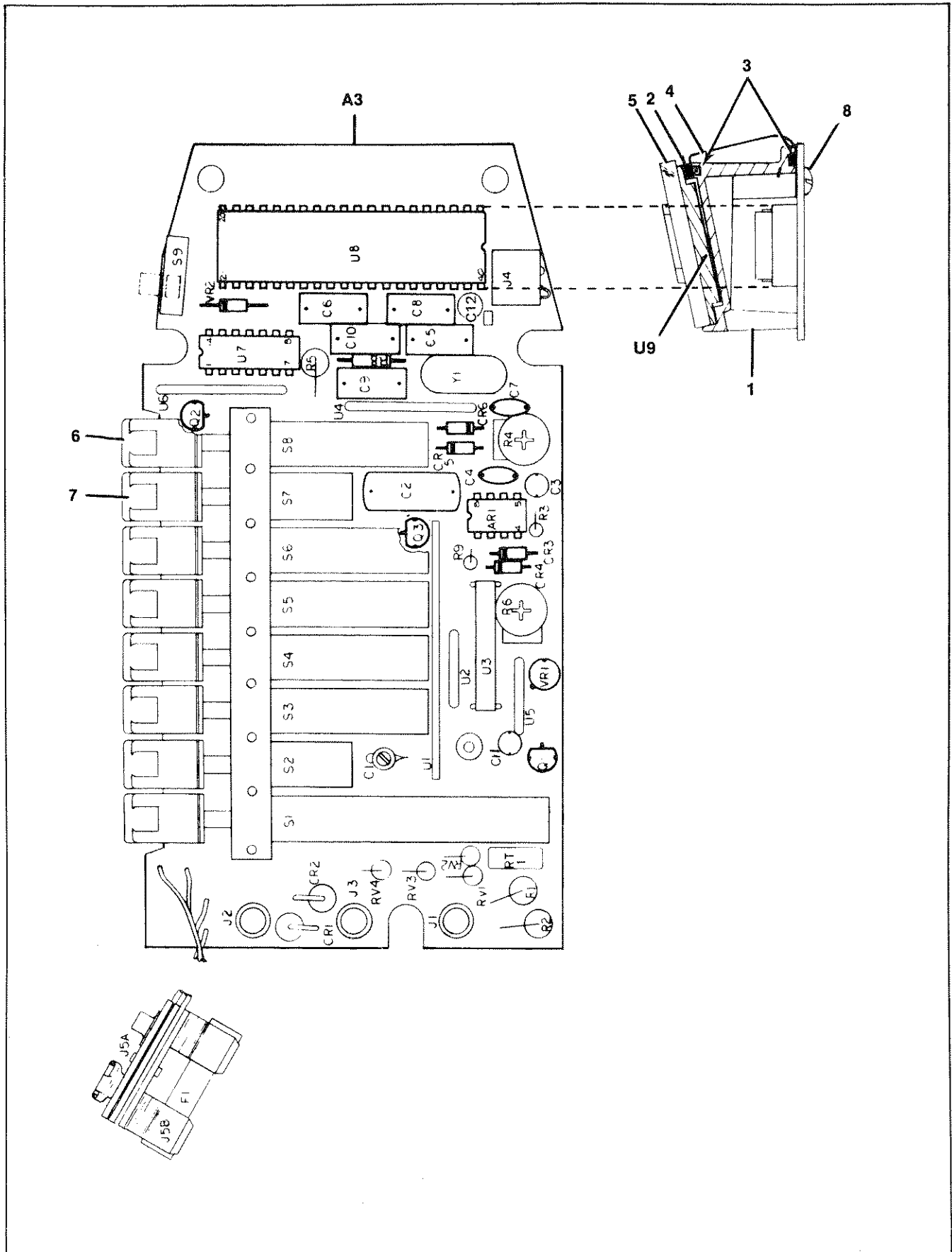

Figure 5-1. 8020A PCB ASSEMBLY

Table 5-3. 8020A PCB Subassembly



REF DESIG OR ITEM NO.	DESCRIPTION	FLUKE STOCK NO.	MFG FED SPLY CDE	MFG PART. NO. OR TYPE	TOT QTY	REC QTY	USE CDE
A3A1	8020A PCB SUBASSEMBLY (8020A-4001S) Figure 5-1	450791			REF		
AR1	IC, dual op amp	418566	89536	418566	1	1	
C1	Cap, var, 0.3 to 1.8 pF	218206	72982	530-001	1	1	
C2	Cap, mylar, 0.022 μ F \pm 10%, 1000V	448183	89536	448183	1		
C3, C11	Cap, Ta, 10 μ F \pm 20%, 15V	193623	56289	196D106X00- 15KA1	2		
C4	Cap, cer, 33 pF \pm 10%, 100V	354852	80031	2222-638- 10339	1		
C5	Cap, mylar, 0.1 μ F \pm 10%, 100V	393439	73445	C280MAH/A 100K	1		
C6, C8	Cap, pily propl. 0.047 μ F \pm 10%, 100V	446773	89536	446773	2		
C7, C12	Cap, cer, 500 pF \pm 10%, 500V	105692	71590	2DDH60N 501K	2		
C9	Cap, poly propl. 0.1 μ F \pm 10%, 100V	446781	89536	446781	1		
C10	Cap, mylar 0.22 μ F \pm 10%, 100V	436113	73445	C280MAH/A 220K	1		
CR1, CR2	Diode, Si	347559	05277	1N5400	2	1	
CR3 thru CR6	Diode, Si	203323	07910	1N4448	4	1	
F1	Fuse, 2 amp/250V American size (1" x 1/4") Metrix size (20 mm x 5 mm)	376582 460972	71400 Electro Union	AGX2 171100-2	1	5	
J4	Connector, dc power	423897	89536	423897	1		
J5	Contact Assembly, battery/fuse American version Metrix version	453910 454413	89536 89536	453910 454413	1		
Q1, Q2, Q3	Xstr, Si, NPN	218396	04723	2N3904	3	1	
R1	Res, comp, 100k \pm 10%, 1W	109397	01121	GB1041	1		
R2	Res, ww, 1k \pm 10%, 2W	474080	89536	474080	1		
R3	Res, comp, 2.2M \pm 5%, 1/4W	198390	01121	CG2255	1		
R4	Res, var, 300 \pm 10%	447722	89536	447722	1	1	

Table 5-3. 8020A PCB Subassembly (Continued)

REF DESIG OR ITEM NO.	DESCRIPTION	FLUKE STOCK NO.	MFG FED SPLY CDE	MFG PART. NO. OR TYPE	TOT QTY	REC QTY	USE CDE
R5	Res, comp, 1M \pm 10%, 1W	109793	01121	GB1051	1		
R6	Res, var, 500 \pm 10%	447730	89536	447730	1	1	
R8	Res, comp, 220k \pm 5%, 1/4W	160937	01121	C92245	1		
R9	Res, comp, 10k \pm 5%, 1/4W	148106	01121	CG1035	1		
RT1	Thermistor, 1k \pm 40% at 25°C	446849	89536	446849	1		
RV1 thru RV4	Varistor, 430V \pm 10%	447672	09214	V150LAX827	4	1	
S1 thru S8	Switch Assembly, pushbutton If assy is milky clear, order If assy is blue, order	453050 453647	89536 89536	453050 453647	1	1	
S9	Switch, slide, spdt	453365	89536	453365	1	1	
U1	Resistor Network (Input Divider)	424085	89536	424085	1	1	
U2	Resistor Network	447706	89536	447706	1	1	
U3	Resistor Network	435727	89536	435727	1	1	
U4	Resistor Network	447698	89536	447698	1	1	
U5	Resistor Network	447680	89536	447680	1	1	
U6	Resistor Network	447714	89536	447714	1	1	
U7	IC, MOS, quad 2-input exclusive OR gate	355222	02735	CD4030AE	1	1	
VR1	Reference, low voltage, 1.22V	452771	89536	452771	1		
VR2	Diode, zener, 12V	113456	07910	1N963A	1		
XU1	Socket, IC, DIL, 40 pin	376244	91506	340-AG39D	1		
Y1	Crystal, 3.2 MHz	460550	89536	460550	1		
	 Assembly is not procurable at this level.						

Section 6

Option & Accessory Information

6-1. INTRODUCTION

6-2. This section of the manual contains information concerning the accessories available for use with the Model 8020A Digital Multimeter (there are no options available at this time). Each accessory as shown in Figure 6-1 is described in general terms under a separate major heading containing the accessory model number. The

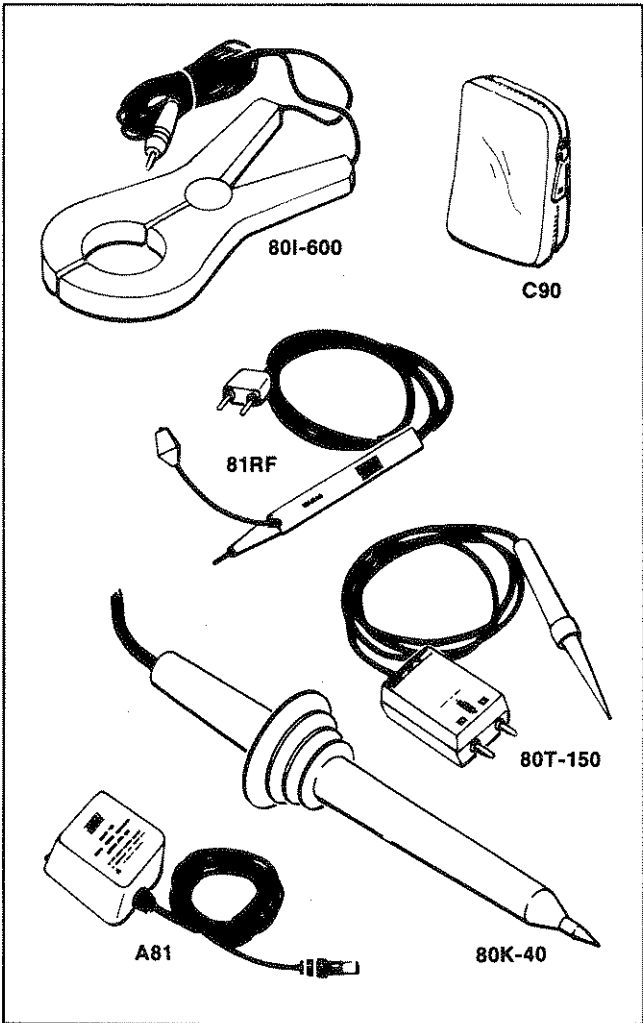

Figure 6-1. 8020A Accessories

depth of detail is intended to give the prospective user an adequate first acquaintance with the features and capabilities of each accessory. Additional information, when necessary, is supplied with the accessory.

6-3. DELUXE CARRYING CASE (C90)

6-4. The C90 Deluxe Carrying Case is a pliable, vinyl, zipper-closed pouch that provides in-field-transport protection for the 8020A as well as convenient storage locations for test leads, operator's guide and other small accessories. A finger-or belt-loop is included on the case as a carrying convenience.

6-5. BATTERY ELIMINATOR (A81)

6-6. The A81 Battery Eliminator converts the 8020A from battery to ac-line operation. It is available in a variety of line-power configurations, as shown in Table 6-1. When connected to the 8020A, it effectively removes and replaces the output of the 8020A's battery.

WARNING
DO NOT SUBSTITUTE A CALCULATOR TYPE BATTERY ELIMINATOR FOR THE A81. THESE UNITS DO NOT PROVIDE THE PROTECTION NECESSARY FOR COMMON MODE MEASUREMENTS UP TO 500V DC. ALWAYS USE THE MODEL A81 FOR AC-LINE OPERATION.

Table 6-1. A81 Model Numbers for Various Input Power Configurations

MODEL NO.	INPUT POWER
A81-100	100V ac ±10%, 48 to 62 HZ
A81-115	115V ac ±10%, 48 to 62 HZ
A81-230-1	230V ac ±10%, 48 to 60HZ (U.S. type plug)
A81-230	230V ac ±10%, 48 to 62 HZ (European type plug)
A81-220	220V ac ±10%, 48 to 62 HZ (European type plug)

6-7. TEMPERATURE PROBE (80T-150)**6-8. Introduction**

6-9. The 80T-150 Temperature Probe converts the 8020A into a direct-reading (1 mV dc/°) °C or °F thermometer. It is ideally suited for surface, ambient and liquid measurement, and lends itself easily to a wide range of design, troubleshooting and evaluation applications. A rugged, fast-responding probe-tip with a 350V dc standoff makes the 80T-150 one of the most versatile and easy-to-use temperature probes available.

6-10. Specifications

Range (°C/°F) -50°C to +150°C or
field selectable by -58°F to 302°F
internal jumpers)

Accuracy ±1°C (1.8°F) from °C
to 100°C, decreasing
linearly to ±3°C (5.4°F)
at -50°C and +150°C

Resolution 0.1°C on 200 mV range

Voltage Standoff . . . 350V dc or peak ac

Power Internal disposable battery;
1,000 hours of continuous use.

6-11. CURRENT TRANSFORMER (80I-600)**6-12. Introduction**

6-13. The Model 80I-600 extends the maximum 2A ac current measuring capability of the 8020A up to a maximum of 600 amps. A clamp-on transformer designed into the probe allows measurements to be made without breaking the circuit under test. In use, the current carrying conductor being measured serves as the transformer's primary while the 80I-600 serves as the secondary. Because of a high efficiency, quadrature type of winding, wire size and location of the conductor within the transformer jaws do not affect accuracy of the current measurement.

6-14. Specifications

Range 2 to 600A ac

Accuracy ±3%

Frequency 30 Hz to 1 kHz

Response

Division Ratio 1000:1

Insulation

Insulation 5 kV

Maximum 2-inch diameter

Conductor Size

6-15. HIGH VOLTAGE PROBE (80K-40)**6-16. Introduction**

6-17. The Model 80K-40 extends the voltage measurement capability of the 8020A up to 40 kV. Internally, the probe contains a special 1000:1 resistive divider. Metal-film resistor with matched temperature coefficients comprise the divider, and provide the probe with its excellent accuracy and stability characteristics. Also, an unusually high input impedance (1000 MΩ) minimizes circuit loading, and thereby contributes to measurement accuracy.

6-18. Specifications

Voltage Range 1kV to 40kV dc or peak ac,
28kV rms ac.

Input Resistance . . . 1000 MΩ

Division Ratio 1000:1

Accuracy DC

Overall Accuracy: 20 kV to 30 kV ±2% (calibrated
at 25 kV).

Upper Limit: Changes linearly from 2% at 30 kV to 4%
at 40 kV.

Lower Limit: Changes linearly from 2% at 20 kV to 4%
at 1 kV.

Accuracy AC ±5% at 60 Hz
(Overall)

6-19. HIGH FREQUENCY PROBE (81RF)**6-20. Introduction**

6-21. The 81RF Probe extends the frequency range of the 8020A's voltage measurements capability to include 100 kHz to 100 MHz inputs from 0.25 to 30V rms. It operates in conjunction with the 8020A dc voltage ranges, and provides a dc output that is calibrated to be equivalent to the rms value of a sinewave input.

6-22. Specifications

Frequency ±1 dB from 100 kHz to
Response 100 MHz

Extended Useful for relative reading
Frequency from 20 kHz to 250 MHz.
Response

Response Responds to peak value of input;
calibrated to read rms value of
a sinewave

Voltage Range 0.25 to 30V rms

Maximum DC 350V dc

Input

Input Impedance . . . 12MΩ shunted by 15 pF

Section 7

Schematic Diagrams

FIGURE	TITLE	PAGE
7-1	8020A PCB Assembly (8020A-1201)	7-2

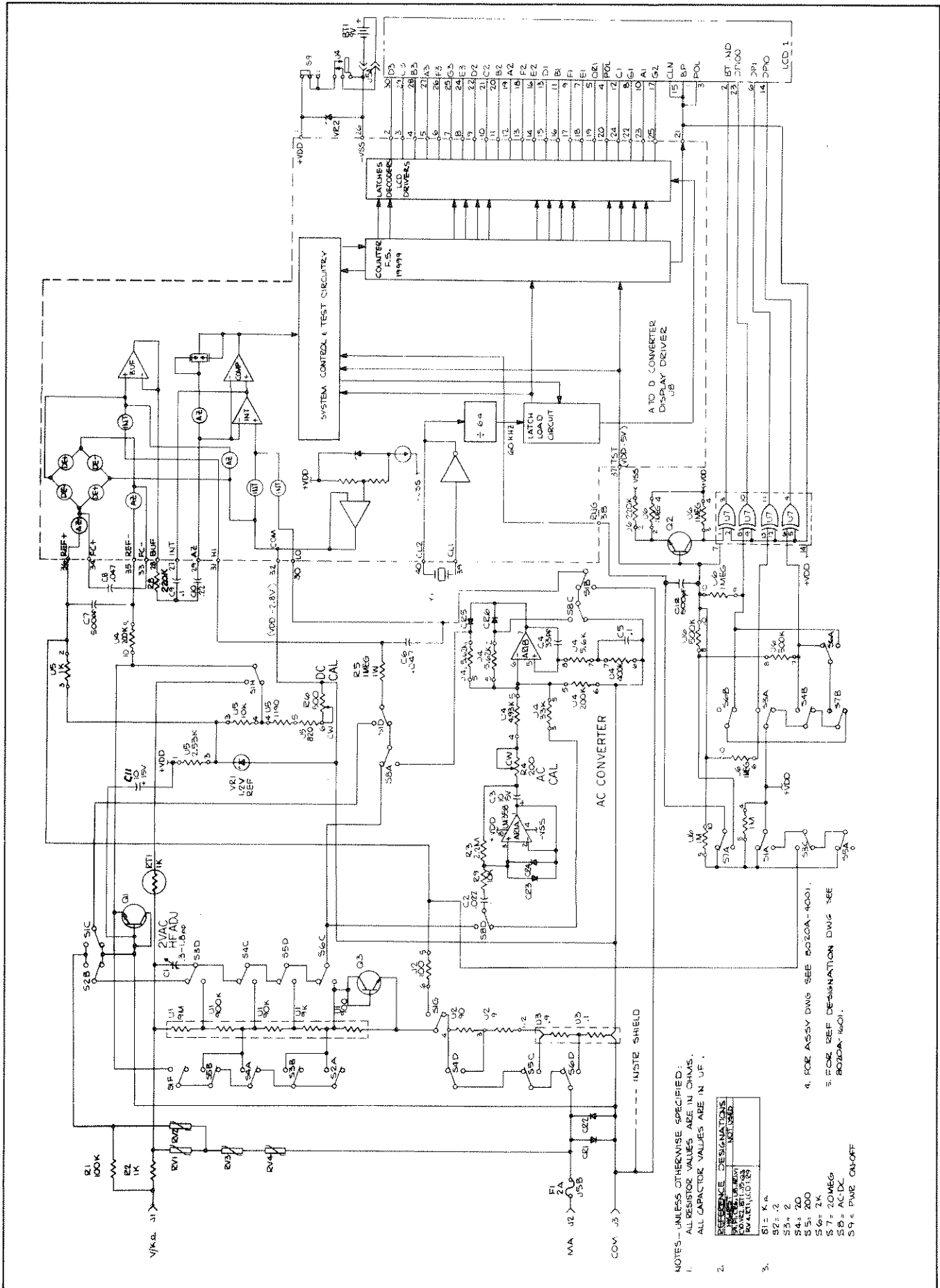

NOTES—UNLESS OTHERWISE SPECIFIED:
 1. ALL RESISTOR VALUES ARE IN OHMS.
 2. ALL CAPACITOR VALUES ARE IN UF.

3.

REFERENCE DESIGNATIONS	VALUES	MANUFACTURER
U1	741	PHILIPS
U2	741	PHILIPS
U3	741	PHILIPS
U4	741	PHILIPS
U5	741	PHILIPS
U6	741	PHILIPS
U7	741	PHILIPS
U8	741	PHILIPS
U9	741	PHILIPS
U10	8020A	PHILIPS

- 4. FOR ASSY DWG SEE 8020A-4001.
- 5. FOR REF DESIGNATION DWG SEE 8020A-16201.
- 59 = PWR ON/OFF

Figure 7-1. 8020A PCB Assembly (8020A-1201) (Sheet 1 of 2)

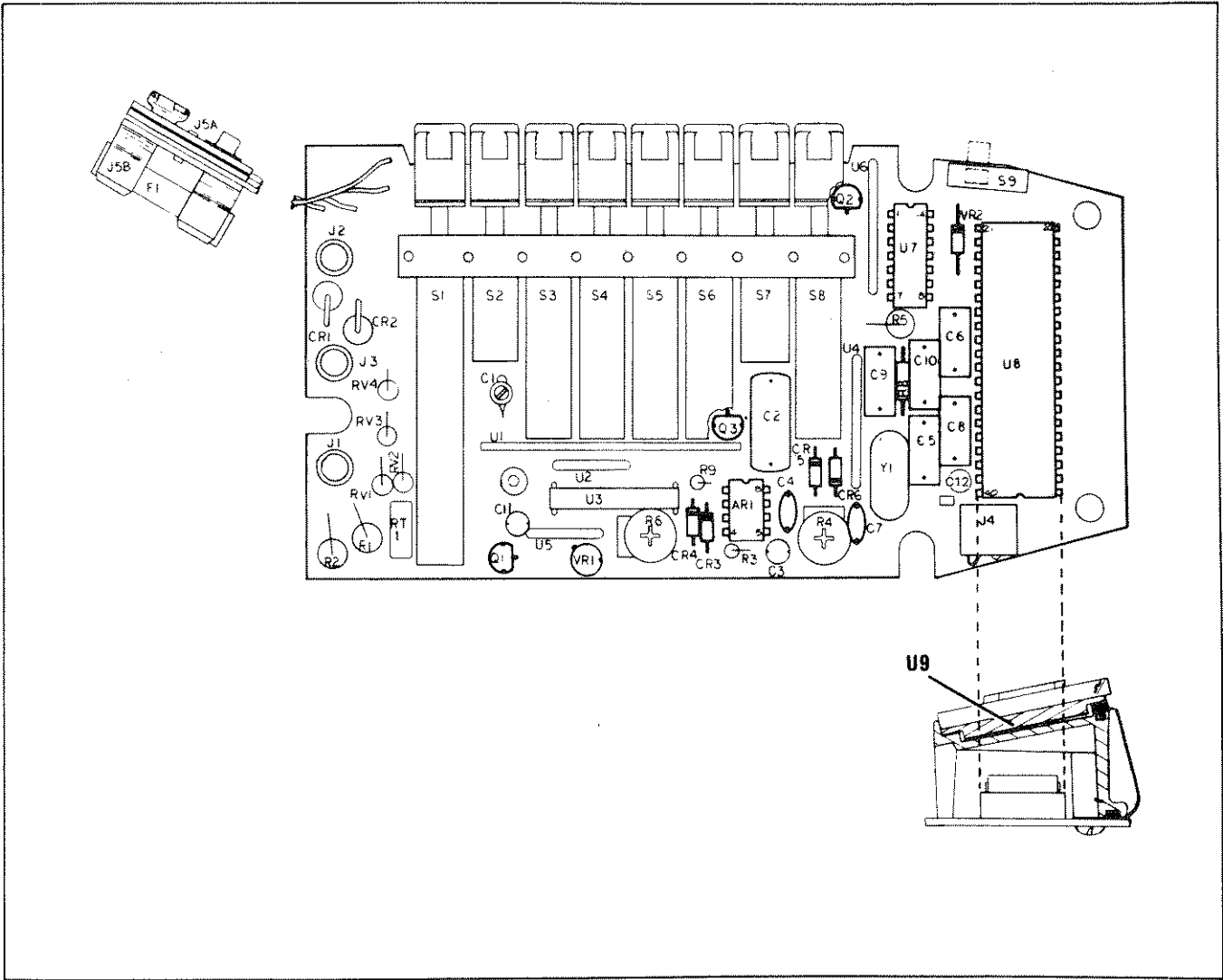

Figure 7-1. 8020A PCB Assembly (8020A-1201) (Sheet 2 of 2)

Fluke Technical Service Centers - U.S. and Canada

<p>Fluke Western Technical Center 2020 N. Lincoln St. Burbank, CA Zip: 91504 Tel: (213) 849-4641</p>	<p>Fluke Midwestern Technical Center 1287 N. Rand Road Des Plaines, IL Zip: 60016 Tel: (312) 298-7470</p>	<p>Fluke Eastern Technical Center 460 Colfax Ave. Clifton, NJ Zip: 07013 Tel: (201) 778-4040</p>	<p>Fluke Canadian Technical Center 6427 Northam Drive L4V 1J5 Tel: (416) 678-1500</p>
---	--	---	---

Sales and Service Locations - International

Supplied and supported by Fluke (Nederland) B.V., P.O. Box 5053, Zevenheuvelenweg 53, Tilburg, Netherlands.

<p>AUSTRIA Walter Rekirsch Elektronische Gerate GmbH & Co. KG. Gottfried-Keller-Gasse 2/9 A-1030 Vienna, Austria Tel: 734294, 725746</p>	<p>CYPRUS Chris Radiovision Ltd. P.O. Box 1989 Nicosia, Cyprus Tel: 66121</p>	<p>FINLAND OY FINDIP AB Teollisuustie 7 02700 Kauniainen, Finland Tel: (080) 502255</p>	<p>GERMAN FEDERAL REPUBLIC Fluke (Deutschland) GmbH 4-Dusseldorf Meineckestrasse 53 West Germany Tel: (211) 450831 Fluke (Deutschland) GmbH 8000 Munich 80 Mutschellestrasse 1 West Germany Tel: (089) 433-21</p>
<p>BELGIUM C.N. Roos S/A 37 Place de Jamblinne de Meux B-1040 Brussels, Belgium Tel: 02-27352135</p>	<p>DENMARK Tage Olsen A/S Teglværksgade 37 DK-2100 Copenhagen, Denmark Tel: 01-294800</p>	<p>FRANCE M.B. Electronique S.A. Rue Fournay ZAC deBUC B.P.N° 31 78530 BUC, France Tel: (01) 9563130</p>	

Sales and Service Locations — International (Concluded)

GREECE

Hellenic Scientific
Representations Ltd.
10 Nymphaeu Street
Athens 615, Greece
Tel: (021) 7792326/705960

ISRAEL

R.D.T. Electronics
Engineering Ltd.
46 Sokolov Street
Ramat Hasharon 47235, Israel
Tel: 483211

ITALY

Sistrel S.p.A.
Via Giuseppe Armellini No. 37
00143 Rome, Italy
Tel: (06) 5915551

Sistrel S.p.A.
Via timavo 66
20099 Sesto S. Giovanni (Milan)
Italy
Tel: (02) 2485233

NETHERLANDS

C.N. Rood, B.V.
Cort van der Lindenstraat 11-13
Rijswijk (Z.H.) 2280AA
Netherlands
Tel: (070) 996360

NORWAY

Morgenstjerne & Co. A/S
Konghellegate 3
P.O. Box 6688, Rodelkka
Oslo 5, Norway
Tel: 02-356110

PORTUGAL

Equipamentos
De Laboratorio Ltda.
P.O. Box 1100
Lisbon 1, Portugal
Tel: 019-976551

Customers in the following countries:
Bulgaria, Czechoslovakia, Hungary, Romania, U.S.S.R.
and Yugoslavia

SPAIN

Ataio Ingenieros S.A.
Enrique Larreta 10-12
Madrid 16, Spain
Tel: 01-7330562

SWEDEN

Teleinstrument AB
P.O. Box 490
S-162 Vallingby-4
Sweden
Tel: 08-380370

SWITZERLAND

Traco Electronic AG
Jenatschstrasse 1
8002 Zurich, Switzerland
Tel: (01) 2010711

TURKEY

Erkman Elektronik Aletler
Necatibey Cad 92/2
Karakoy/Istanbul
Turkey
Tel: 441546, 447651

UNITED KINGDOM

Fluke International Corp.
Garnett Close
Watford, WD2 4TT, England
Tel: (0923) 33066

Contact: Amtest Associates Ltd., P.O. Box 55, Addlestone,
Surrey, KT 15 1DU, England, Tel: (0932) 52121.

Supplied and supported by Fluke International Corporation, P.O. Box 43210, Mountlake Terrace, WA 98043

ARGENTINA

Coasin S.A.
Virrey del Pino 4071
Buenos Aires, Argentina
Tel: 523185

AUSTRALIA

Eimeasco Instruments, Pty. Ltd.
P.O. Box 30
Concord, N.S.W.
Australia 2137
Tel: (02) 736-2888

BOLIVIA

Coasin Bolivia S.R.L.
Casilla 72-95
La Paz, Bolivia
Tel: 40962

BRAZIL

Arotec S.A.
Industrial e Comercio
Av. Pacaembu 811
Sao Paulo, S.P. Brazil

CARIBBEAN

West Indies Sales Co., Ltd.
7360A N.W. 66th St.
Miami, FL 33166
Tel: (305) 592-8188

CHILE

Coasin Chile Ltda.
Ismael Valdes Vergara 336 of. 41
Casilla 14588 - Correo 21
Santiago, Chile
Tel: 396713

CHINA

China National Machinery
Import and Export Corp.
P.O. Box 49
Peking
People's Republic of China

COLUMBIA

Assistec Limitada
Apartado Aereo 12322
Bogota 1, Columbia
Tel: 419331

ECUADOR

Proteco Coasin CIA, Ltda.
Apartado 228A
Quito, Ecuador
Tel: 526759

EGYPT

Lotus Engineering Organisation
P.O. Box 1252
Cairo, Egypt
Tel: 71617

HONG KONG

Gilman & Co. Ltd.
P.O. Box 56
Hong Kong
Tel: 794266

ICELAND

Kristjan O. Skagfjord Ltd.
P.O. Box 906
Reykjavik, Iceland
Tel: 24120

INDIA

Hinditron Services Pvt. Ltd.
69/A.L. Jagmohandas Marg
Bombay 400 006 India
Tel: 365344

INDONESIA

C.V. Cempaka Putih
Jl. Kramat Pulo 33
Jakarta Pusat, Indonesia
Tel: 41332
C.V. Dwi Tunggal Djaja
Jl. Pintu Air, No. 9
Jakarta, Indonesia
Tel: 46369

IRAN

Irantronics Company Ltd.
20 Salm Road, Roosevelt Ave.
Tehran, Iran
Tel: 828294, 831564

JORDAN

Trading & Agricultural
Development Company
P.O. Box 567
Amman, Jordan
Tel: 23052, 23470

KENYA

Advanced Communications Ltd.
City House, Wabera Street
P.O. Box 30635
Nairobi, Kenya
East Africa
Tel: 31955, 338132

KOREA

Shin Han
Scientific Co., Ltd.
International P.O. Box 1250
Seoul, Korea
Tel: 76-2761

KUWAIT

Tareq Company
P.O. Box Safat 20506
Kuwait, Arabian Gulf
Tel: 436100, 436045

LEBANON

Mabek Electronics
P.O. Box 11 - 3823
Beirut, Lebanon
Tel: 252631, 348728

MALAYSIA

O'Connor's (Pte) Ltd.
P.O. Box 91
Petaling Jaya, Selangor
West Malaysia
Tel: 51563

MEXICO

C.J. Christensen S.A. de C.V.
Melchor Ocampo 150-8
Mexico 4, D.F.
Tel: 535 22 58

NEW ZEALAND

W & K McLean Ltd.
P.O. Box 3097
Auckland, New Zealand
Tel: 587-037

NIGERIA

Mofat Engineering Co., Ltd.
P.O. Box 6369
Lagos, Nigeria

PAKISTAN

Pak International Operations
505 Muhammadi House
McLeod Road
P.O. Box 5323
Karachi, Pakistan

PERU

Importaciones Y Representaciones
Electronicas S.A.
Avda. Franklin D. Roosevelt 105
Lima 1, Peru
Tel: 288650

POLAND

Unitronex Corporation
3158 Des Plaines Ave.
Des Plaines, IL 60018
Tel: (312) 298-1155

SAUDI ARABIA

Electronic Equipment
Marketing Establishment
P.O. Box 3750
Riyadh, Saudi Arabia
Tel: 32700

SINGAPORE

O'Connor's (Pte) Ltd.
98 Pasir Panjang Road
Singapore 5, Singapore
Tel: 637944

SOUTH AFRICA

Fluke SA (Pty) Ltd.
P.O. Box 39797
Bramley 2018
Republic of South Africa
Tel: (011) 786-3170

TAIWAN

Tatung Company
22 Chungshan North Road
2nd Sec.
Taipei, Taiwan
Rep. of China
Tel: 5215252

THAILAND

Dynamic Supply
Engineering R.O.P.
No. 56 Ekamai, Sukhumvit 63
Bankok 11, Thailand
Tel: 914434, 928532

URUGUAY

Coasin Uruguaya S.R.L.
Cerrito 617 - 4° Piso
Montevideo
Uruguay
Tel: 917978

VENEZUELA

Coasin C.A.
APDO Postal 50939
Sabana Grande No. 1
Caracas 105, Venezuela
Tel: 782-9109

SERVICE REPORT

(For U.S. and Canadian customers only. International customers must contact their nearest service center for service information)

This report must be completed in order for your Fluke Model 8020A to be repaired at a Fluke Service Center. If you have owned your 8020A for 12 months or less, be sure to include a copy of your sales receipt, invoice, purchase order, etc. to establish warranty status. If you have owned your 8020A for more than 12 months, enclose a check or money order for the amount of \$40.00* to cover any normal repair, calibration, case refurbishment, and return shipping charges. Determine your nearest U.S./Canadian Fluke Service Center from the list on the opposing page.

**Price subject to change without notice.*

To ship your 8020A, remove the battery and safely package the unit in the original container (include any accessories). Complete this label, cut out and tape onto the shipping container. We advise that you insure your instrument, and use air mail to minimize transit time. (Please note that shipping damage is not covered by warranty.)

FILL-IN AND CUT-OUT FOR SHIPPING LABEL

FROM: _____

FLUKE SERVICE CENTER

STREET _____

CITY _____ STATE/PROV _____ ZIP _____

Service Center Use Only

In order to properly receive your repaired instrument, please print the desired return shipping address (use pen).

PACKING LIST: FILL-IN, CUT-OUT, AND ENCLOSE WITH INSTRUMENT

Complete this portion to expedite repair.

PACKING LIST

MODEL NO.	QTY.	SERIAL NUMBER (S)
8020A		

TROUBLE SYMPTOMS _____

DATE OF PURCHASE _____ PURCHASED FROM _____

REPAIRS MADE (SERVICE CENTER USE) _____

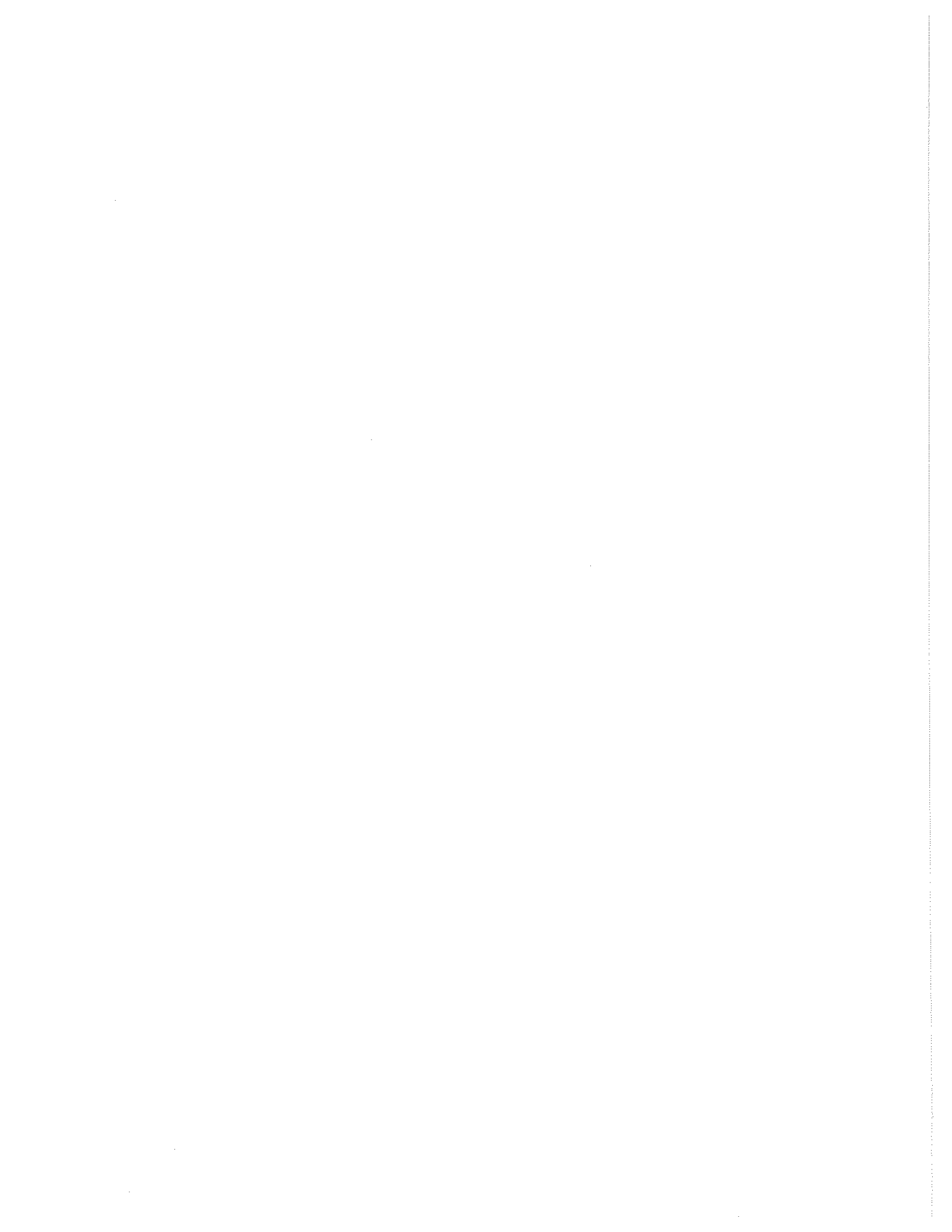

LIMITED WARRANTY

The JOHN FLUKE MFG. CO., INC., warrants each voltmeter it manufactures to be free from defects in material and workmanship under normal use and service for the period of 1 year from date of purchase. This warranty extends only to the original purchaser. This warranty shall not apply to fuses, disposable batteries (rechargeable type batteries are warranted for 90-days), or any product or parts which have been subject to misuse, neglect, accident or abnormal conditions of operations.

In the event of failure of a product covered by this warranty, John Fluke Mfg. Co., Inc., will repair and calibrate an instrument returned to an authorized Service Facility within 1 year of the original purchase; provided the warrantor's examination discloses to its satisfaction that the product was defective. The warrantor may, at its option, replace the product in lieu of repair. With regard to any instrument returned within 1 year of the original purchase, said repairs or replacement will be made without charge. If the failure has been caused by misuse, neglect, accident or abnormal conditions of operations, repairs will be billed at a nominal cost. In such case, an estimate will be submitted before work is started, if requested.

ANY IMPLIED WARRANTIES OF MERCHANTABILITY OR FITNESS FOR A PARTICULAR PURPOSE OR USE SHALL BE LIMITED TO A PERIOD OF TWELVE MONTHS FROM THE DATE OF PURCHASE. THE FOREGOING WARRANTY IS IN LIEU OF ALL OTHER EXPRESS WARRANTIES. JOHN FLUKE MFG. CO., INC., SHALL NOT BE LIABLE FOR ANY SPECIAL, INCIDENTAL OR CONSEQUENTIAL DAMAGES, WHETHER IN CONTRACT, TORT, OR OTHERWISE.

NOTE: Some states do not allow limitations on how long an implied warranty lasts, or the exclusion or limitation of incidental or consequential damages, so the above limitations or exclusion may not apply to you. This warranty gives you specific legal rights, and you may also have other rights which vary from state to state.

If any failure occurs, the following steps should be taken:

1. Notify the JOHN FLUKE MFG. CO., INC., or nearest Service facility, giving full details of the difficulty, and include the Model number, type number, and serial number. On receipt of this information, service data or shipping instructions will be forwarded to you.
2. On receipt of the shipping instructions, forward the instrument, transportation prepaid. Repairs will be made at the Service Facility and the instrument returned, transportation prepaid.

SHIPPING TO MANUFACTURER FOR REPAIR OR ADJUSTMENT

All shipments of JOHN FLUKE MFG. CO., INC., instruments should be made via United Parcel Service or "Best Way" prepaid. The instrument should be shipped in the original packing carton; or if it is not available, use any suitable container that is rigid and of adequate size. If a substitute container is used, the instrument should be wrapped in paper and surrounded with at least four inches of excelsior or similar shock-absorbing material.

CLAIM FOR DAMAGE IN SHIPMENT TO ORIGINAL PURCHASER

The instrument should be thoroughly inspected immediately upon original delivery to purchaser. All material in the container should be checked against the enclosed packing list. The manufacturer will not be responsible for shortages against the packing sheet unless notified immediately. If the instrument is damaged in any way, a claim should be filed with the carrier immediately. (To obtain a quotation to repair shipment damage, contact the nearest Fluke Technical Center.) Final claim and negotiations with the carrier must be completed by the customer.

The JOHN FLUKE MFG. CO., INC. will be happy to answer all application or use questions, which will enhance your use of this instrument. Please address your requests or correspondence to: JOHN FLUKE MFG. CO., INC., P.O. BOX 43210, MOUNTLAKE TERRACE, WASHINGTON 98043, ATTEN: Sales Dept. For European Customers: Fluke (Nederland) B.V., Zevenhevelenweg 53, Tilburg, The Netherlands.

* For European customers, Air Freight prepaid.

John Fluke Mfg. Co., Inc., • P.O. Box 43210 • Mountlake Terrace, Washington 98043

Appendix A

MANUAL CHANGE INFORMATION

INTRODUCTION

This appendix contains information necessary to backdate the manual to conform with instruments using an older pcb assembly. To identify the pcb used in your instrument, refer to the revision letter marked in the upper right-hand corner on the component side of the pcb. If your instrument revision letter is G, this manual applies directly.

NEWER INSTRUMENTS

As changes and improvements are made to the instrument, they are identified by incrementing the revision letter on the pcb assembly. These changes are documented on a supplemental change/errata sheet which, when applicable, appears at the front of the manual. If your manual requires a change/errata but does not contain one, contact your nearest sales representative. Be prepared to provide him with the revision letter of your instrument.

OLDER INSTRUMENTS

To backdate this manual to conform with earlier revision-letter instruments perform the changes indicated in Table 1. Make the changes in the order given.

Table 1. Backdating Requirements

TO CHANGE MANUAL FROM REV G TO:	PERFORM CHANGES
B	5, 4, 3, 2, 1
C	5, 4, 3, 2
D	5, 4, 3
E	5, 4
F	5

CHANGE #1

Reference designator drawing was corrected. No manual change is required.

CHANGE #2

Bill of materials was updated to include 50 Hz components; i.e., metric fuse, fuse contact (J5), crystal (3.2 MHz). No manual change is required.

CHANGE #3

In Section 6, 8020A PCB Subassembly parts list, Table 5-3, make the following changes:

- Change resistor R8 from 220k $\pm 5\%$, 1/4 W; 160937; CG2245 to 180k $\pm 5\%$, 1/4W; 193441; CG2245.

- To crystal Y1 add the following alternate description and part no. for use in units designed for 60 Hz environments.

Crystal, 3.84 MHz (60 Hz); 447615; 89536; 447615

On the 8020A schematic, Figure 7-1, change the value of resistor R8 from 220k to 180k.

In Section 3, paragraph 3-9, A/D Converter, indicate the use of one-of-two crystals; 3.2 MHz for 50 Hz environments and 3.84 MHz for 60 Hz environments.

CHANGE #4

In Section 5, Table 5-3, the part number for R2 was changed from 446831 to 474080. The value of R2 was not changed. no manual change is required.

CHANGE #5

In Section 5, Figure 5-1, delete capacitor C12.

In Section 5, Table 5-3, delete reference designator C12 from C7, C12. Also change the total quantity from 2 to 1.

In Section 7, Figure 7-1, sheet 1 of 2 and 2 of 2, delete capacitor C12.

Change/Errata Information

Issue No: 1 10/78

This change/errata contains information necessary to ensure the accuracy of the following manual. Enter the corrections in the manual if either one of the following conditions exist:

1. The instrument's PCB revision letter is lower than that which is indicated at the beginning of the change/errata.
2. No revision letter is indicated at the beginning of the change/errata.

MANUAL

Title: MODEL 8020A DIGITAL MULTIMETER
Print Date: AUGUST 1977
Rev and Date: 2 - 5/78

C/E PAGE EFFECTIVITY

Page No.	Print Date
1	10/78

CHANGE #1-11764

Rev. -H, make the following changes:

On page 5-5:

FROM: Q1, Q2, Q3/Xstr, Si, NPN/218396/09723/2N3904/3/1
 TO: Q1, Q2, Q3/Xstr, Si, NPN/483859/89536/483859/3/1

ERRATA #1

On page 2-4, make the following changes:

Delete the Note immediately following Figure 2-3, as shown below:

NOTE

Noise rejection is optimized (≈ 60 dB) when the 8020A is operated in its normal line-frequency environment, i.e., 50 or 60 Hz. Units designed for 50 Hz environments are identified by a "50/" preceding the serial number. Units without the "50/" are 60 Hz models. If operation in both environments is anticipated, the 50 Hz model is preferred since it provides ≈ 60 dB rejection at both frequencies on all voltage and current ranges.

CHANGE #2-11924

Rev. -J, make the following changes:

On page 5-4:

DELETE Q3 as shown:

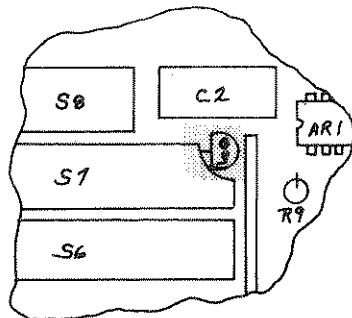

On page 5-5:

FROM: Q1, Q2, Q3/Xstr, Si, NPN/483859/89536/483859/3/1
 TO: Q1, Q2/Xstr, Si NPN/483859/89536/483859/2/1

On page 7-2, Figure 7-1, 8020A PCB Assembly, make the following changes:

